

**Immersion / screw-in / duct temperature sensors
with passive output**

Patented quality product (Immersion sensor patent no. DE 10 2012 017 500.0)

THERMASGARD® TF 43 is a resistance thermometer with a passive output, housing made from impact-resistant plastic with snap-on lid, and straight protective tube.

THERMASGARD® TF 65 is a resistance thermometer with a passive output, housing made from impact-resistant plastic with quick-locking screws, and straight protective tube.

These immersion / screw-in / duct temperature sensors are electric contact thermometers for temperature measurement in liquids and gases, which are installed for example in piping systems and vessels. For aggressive media, stainless steel immersion sleeves must be used.

Applications of these temperature sensors in piping systems, in heating technology, in storage tanks, in district heating compact stations, in hot and cold-water systems, in oil and lubricant circulation systems, in mechanical, apparatus and plant engineering as well as in the entire industrial sector.

TECHNICAL DATA

Measuring range:	-30...+150 °C (T_{max} NTC = +150 °C, T_{max} LM235Z = +125 °C)
Sensors / output:	see table, passive (Perfect Sensor Protection) (optional also with two sensors)
Connection type:	2-wire connection (4-wire connection on PT100/PT1000A, optional on other sensors)
Testing current:	< 0.6 mA (Pt1000) < 1.0 mA (Pt100) < 0.3 mA (Ni1000, Ni1000 TK5000) < 2.0 mW (NTC xx) 400 µA...5 mA (LM235Z)
Insulating resistance:	≥ 100 MΩ, at +20 °C (500 V DC)
Ambient temperature:	-20...+100 °C
Housing:	plastic, UV-resistant, material polyamide, 30% glass-globe reinforced, colour traffic white (similar to RAL 9016) TF 43 with snap-on lid TF 65 with quick-locking screws (slotted / Phillips head combination)
Housing dimensions:	72 x 64 x 37.8 mm (Tyr 1 / Tyr 01)
Cable connection:	cable gland , plastic (M 16 x 1.5; with strain relief, exchangeable, max. inner diameter 10.4 mm) or M12 connector according to DIN EN 61076-2-101 (optional on request)
Electrical connection:	0.14 - 1.5 mm ² , via terminal screws
Protective tube:	stainless steel, V4A (1.4571), Ø = 6 mm, inserted length (EL) = 50 - 400 mm (see table)
Permissible humidity:	< 95% r. H., non-precipitating air
Protection class:	III (according to EN 60 730)
Protection type:	TF 43 IP 54 (according to EN 60 529)* Housing tested, TÜV SÜD, Report No. 713160960A (Tyr 01) TF 65 IP 67 (according to EN 60 529)* Housing tested, TÜV SÜD, Report No. 713139052 (Tyr 1) * Housing in the built-in state

ACCESSORIES

MF-15-K	Mounting flange , plastic, 56.8 x 84.3 mm, Ø = 15.2 mm tube gland, T_{max} = +100 °C
TH08-ms/xx	Immersion sleeve , brass, nickel-plated, Ø = 8 mm, T_{max} = +150 °C, p_{max} = 10 bar
TH08-VA/xx	Immersion sleeve , stainless steel, V4A (1.4571), Ø = 8 mm, T_{max} = +600 °C, p_{max} = 40 bar
TH08-VA/xx/90	Immersion sleeve , stainless steel, V4A (1.4571), with neck tube (90 mm), Ø = 8 mm, T_{max} = +600 °C, p_{max} = 40 bar

High-performance encapsulation against
vibration, mechanical stress and humidity

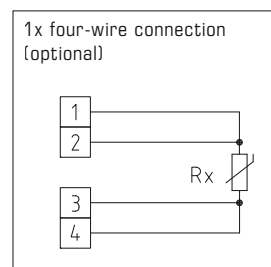
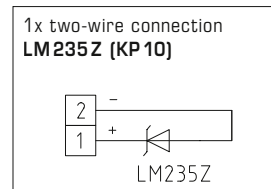
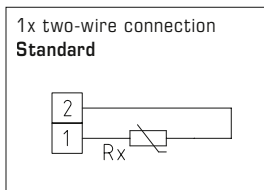



S+S REGELTECHNIK

THERMASGARD® TF 43
THERMASGARD® TF 65

Immersion / screw-in / duct temperature sensors
with passive output

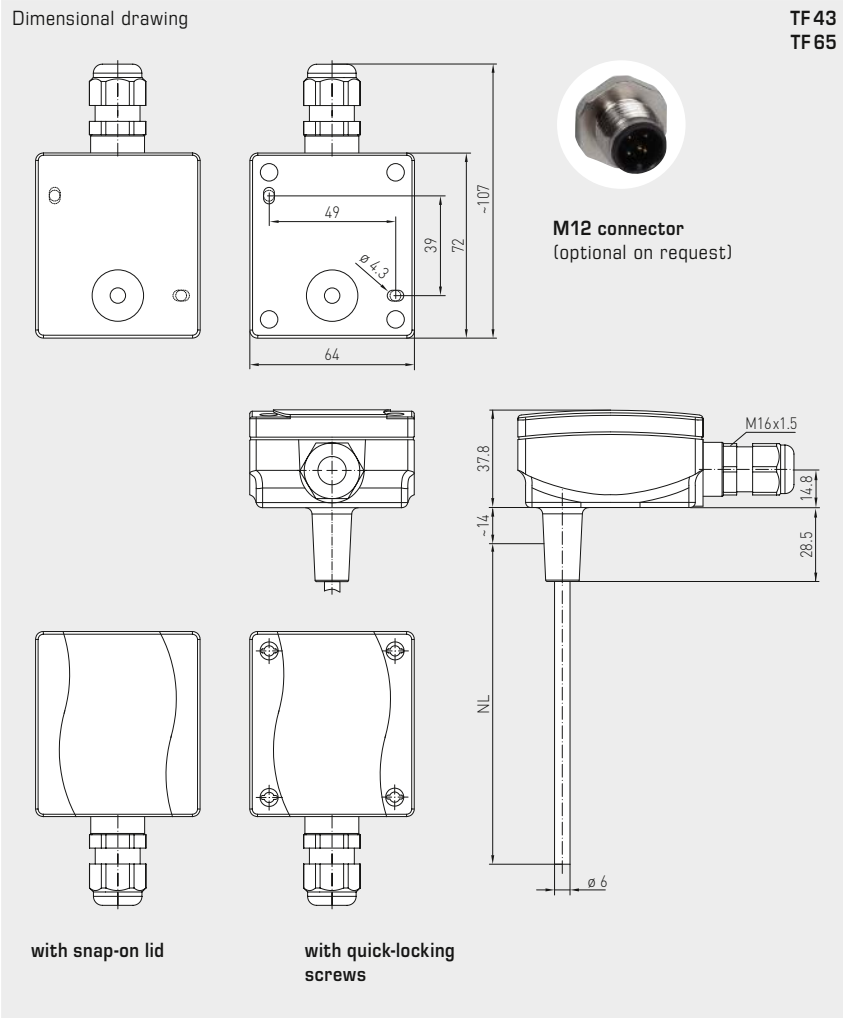

TF43
with snap-on lid
(IP54)



TF65
with quick-locking screws
(IP67)



PATENTED

TFxx
Basic device
with accessories

THERMASGARD® TF 65 Temperature sensors (Basic device with quick-locking screws), *Premium*

Type / WG03 / EL	Sensor / Output	Item No.	Price
TF65 PT100 xx	Pt100	IP 67	
TF65 Pt100 50mm	Pt100 (according to DIN EN 60 751, class B)	1101-7020-1013-000	33,35 €
TF65 Pt100 100mm	Pt100 (according to DIN EN 60 751, class B)	1101-7020-1023-000	34,71 €
TF65 Pt100 150mm	Pt100 (according to DIN EN 60 751, class B)	1101-7020-1033-000	36,07 €
TF65 Pt100 200mm	Pt100 (according to DIN EN 60 751, class B)	1101-7020-1043-000	36,60 €
TF65 Pt100 250mm	Pt100 (according to DIN EN 60 751, class B)	1101-7020-1053-000	38,27 €
TF65 Pt100 300mm	Pt100 (according to DIN EN 60 751, class B)	1101-7020-1063-000	39,53 €
TF65 Pt100 350mm	Pt100 (according to DIN EN 60 751, class B)	1101-7020-1073-000	40,25 €
TF65 Pt100 400mm	Pt100 (according to DIN EN 60 751, class B)	1101-7020-1083-000	41,20 €
TF65 PT1000 xx	Pt1000	IP 67	
TF65 Pt1000 50mm	Pt1000 (according to DIN EN 60 751, class B)	1101-7020-5011-000	35,65 €
TF65 Pt1000 100mm	Pt1000 (according to DIN EN 60 751, class B)	1101-7020-5021-000	37,02 €
TF65 Pt1000 150mm	Pt1000 (according to DIN EN 60 751, class B)	1101-7020-5031-000	38,37 €
TF65 Pt1000 200mm	Pt1000 (according to DIN EN 60 751, class B)	1101-7020-5041-000	38,89 €
TF65 Pt1000 250mm	Pt1000 (according to DIN EN 60 751, class B)	1101-7020-5051-000	40,57 €
TF65 Pt1000 300mm	Pt1000 (according to DIN EN 60 751, class B)	1101-7020-5061-000	41,82 €
TF65 Pt1000 350mm	Pt1000 (according to DIN EN 60 751, class B)	1101-7020-5071-000	42,34 €
TF65 Pt1000 400mm	Pt1000 (according to DIN EN 60 751, class B)	1101-7020-5081-000	43,07 €
TF65 PT1000A xx	Pt1000A	IP 67	
TF65 Pt1000A 50mm	Pt1000 (according to VDI/VDE 3512, class A-TGA)	1101-7020-6013-000	37,36 €
TF65 Pt1000A 100mm	Pt1000 (according to VDI/VDE 3512, class A-TGA)	1101-7020-6023-000	37,96 €
TF65 Pt1000A 150mm	Pt1000 (according to VDI/VDE 3512, class A-TGA)	1101-7020-6033-000	39,94 €
TF65 Pt1000A 200mm	Pt1000 (according to VDI/VDE 3512, class A-TGA)	1101-7020-6043-000	40,46 €
TF65 Pt1000A 250mm	Pt1000 (according to VDI/VDE 3512, class A-TGA)	1101-7020-6053-000	42,14 €
TF65 Pt1000A 300mm	Pt1000 (according to VDI/VDE 3512, class A-TGA)	1101-7020-6063-000	43,49 €
TF65 Pt1000A 350mm	Pt1000 (according to VDI/VDE 3512, class A-TGA)	1101-7020-6073-000	44,85 €
TF65 Pt1000A 400mm	Pt1000 (according to VDI/VDE 3512, class A-TGA)	1101-7020-6083-000	45,06 €
TF65 Ni1000 xx	Ni1000	IP 67	
TF65 Ni1000 50mm	Ni1000 (according to DIN EN 43 760, class B, TCR = 6180 ppm/K)	1101-7020-9011-000	35,03 €
TF65 Ni1000 100mm	Ni1000 (according to DIN EN 43 760, class B, TCR = 6180 ppm/K)	1101-7020-9021-000	36,70 €
TF65 Ni1000 150mm	Ni1000 (according to DIN EN 43 760, class B, TCR = 6180 ppm/K)	1101-7020-9031-000	38,06 €
TF65 Ni1000 200mm	Ni1000 (according to DIN EN 43 760, class B, TCR = 6180 ppm/K)	1101-7020-9041-000	38,58 €
TF65 Ni1000 250mm	Ni1000 (according to DIN EN 43 760, class B, TCR = 6180 ppm/K)	1101-7020-9051-000	40,25 €
TF65 Ni1000 300mm	Ni1000 (according to DIN EN 43 760, class B, TCR = 6180 ppm/K)	1101-7020-9061-000	41,50 €
TF65 Ni1000 350mm	Ni1000 (according to DIN EN 43 760, class B, TCR = 6180 ppm/K)	1101-7020-9071-000	42,34 €
TF65 Ni1000 400mm	Ni1000 (according to DIN EN 43 760, class B, TCR = 6180 ppm/K)	1101-7020-9081-000	42,87 €
TF65 NI1000TK xx	Ni1000 TK5000	IP 67	
TF65 NiTK 50mm	Ni1000 TK5000 (TCR = 5000 ppm/K), LG-Ni1000	1101-7021-0011-000	35,03 €
TF65 NiTK 100mm	Ni1000 TK5000 (TCR = 5000 ppm/K), LG-Ni1000	1101-7021-0021-000	36,70 €
TF65 NiTK 150mm	Ni1000 TK5000 (TCR = 5000 ppm/K), LG-Ni1000	1101-7021-0031-000	38,06 €
TF65 NiTK 200mm	Ni1000 TK5000 (TCR = 5000 ppm/K), LG-Ni1000	1101-7021-0041-000	38,58 €
TF65 NiTK 250mm	Ni1000 TK5000 (TCR = 5000 ppm/K), LG-Ni1000	1101-7021-0051-000	40,25 €
TF65 NiTK 300mm	Ni1000 TK5000 (TCR = 5000 ppm/K), LG-Ni1000	1101-7021-0061-000	41,50 €
TF65 NiTK 350mm	Ni1000 TK5000 (TCR = 5000 ppm/K), LG-Ni1000	1101-7021-0071-000	42,34 €
TF65 NiTK 400mm	Ni1000 TK5000 (TCR = 5000 ppm/K), LG-Ni1000	1101-7021-0081-000	39,14 €

Continued on next page...

High-performance encapsulation against
vibration, mechanical stress and humidity





THERMASGARD® TF 65 Temperature sensors (Basic device with quick-locking screws), <i>Premium</i>			
Type/WG03 /EL	Sensor/Output	Item No.	Price
TF65 LM235Z xx	LM235Z	IP67	
TF65 LM235Z 50mm	LM235Z (TCR = 10 mV/K; 2.73 V at 0 °C), KP10	1101-7022-1011-000	33,87 €
TF65 LM235Z 100mm	LM235Z (TCR = 10 mV/K; 2.73 V at 0 °C), KP10	1101-7022-1021-000	35,13 €
TF65 LM235Z 150mm	LM235Z (TCR = 10 mV/K; 2.73 V at 0 °C), KP10	1101-7022-1031-000	36,49 €
TF65 LM235Z 200mm	LM235Z (TCR = 10 mV/K; 2.73 V at 0 °C), KP10	1101-7022-1041-000	37,02 €
TF65 LM235Z 250mm	LM235Z (TCR = 10 mV/K; 2.73 V at 0 °C), KP10	1101-7022-1051-000	38,79 €
TF65 LM235Z 300mm	LM235Z (TCR = 10 mV/K; 2.73 V at 0 °C), KP10	1101-7022-1061-000	40,05 €
TF65 LM235Z 350mm	LM235Z (TCR = 10 mV/K; 2.73 V at 0 °C), KP10	1101-7022-1071-000	40,78 €
TF65 LM235Z 400mm	LM235Z (TCR = 10 mV/K; 2.73 V at 0 °C), KP10	1101-7022-1081-000	41,30 €
TF65 NTC 1.8K xx	NTC 1.8K	IP67	
TF65 NTC1,8K 50mm	NTC 1.8K	1101-7021-2011-000	32,00 €
TF65 NTC1,8K 100mm	NTC 1.8K	1101-7021-2021-000	33,35 €
TF65 NTC1,8K 150mm	NTC 1.8K	1101-7021-2031-000	34,71 €
TF65 NTC1,8K 200mm	NTC 1.8K	1101-7021-2041-000	35,13 €
TF65 NTC1,8K 250mm	NTC 1.8K	1101-7021-2051-000	36,90 €
TF65 NTC1,8K 300mm	NTC 1.8K	1101-7021-2061-000	38,16 €
TF65 NTC1,8K 350mm	NTC 1.8K	1101-7021-2071-000	38,84 €
TF65 NTC1,8K 400mm	NTC 1.8K	1101-7021-2081-000	39,73 €
TF65 NTC10K xx	NTC 10K	IP67	
TF65 NTC10K 50mm	NTC 10K	1101-7021-5011-000	32,00 €
TF65 NTC10K 100mm	NTC 10K	1101-7021-5021-000	33,35 €
TF65 NTC10K 150mm	NTC 10K	1101-7021-5031-000	34,71 €
TF65 NTC10K 200mm	NTC 10K	1101-7021-5041-000	35,13 €
TF65 NTC10K 250mm	NTC 10K	1101-7021-5051-000	36,90 €
TF65 NTC10K 300mm	NTC 10K	1101-7021-5061-000	38,16 €
TF65 NTC10K 350mm	NTC 10K	1101-7021-5071-000	38,84 €
TF65 NTC10K 400mm	NTC 10K	1101-7021-5081-000	39,73 €
TF65 NTC20K xx	NTC 20K	IP67	
TF65 NTC20K 50mm	NTC 20K	1101-7021-6011-000	32,00 €
TF65 NTC20K 100mm	NTC 20K	1101-7021-6021-000	33,35 €
TF65 NTC20K 150mm	NTC 20K	1101-7021-6031-000	34,71 €
TF65 NTC20K 200mm	NTC 20K	1101-7021-6041-000	35,13 €
TF65 NTC20K 250mm	NTC 20K	1101-7021-6051-000	36,80 €
TF65 NTC20K 300mm	NTC 20K	1101-7021-6061-000	38,16 €
TF65 NTC20K 350mm	NTC 20K	1101-7021-6071-000	38,84 €
TF65 NTC20K 400mm	NTC 20K	1101-7021-6081-000	39,73 €
Note:	Other sensors optional	on request	
Optional:	Cable connection with M12 connector according to DIN EN 61076-2-101	on request	



Immersion / screw-in / duct temperature sensors
with passive output

THERMASGARD® TF 43 Temperature sensors (Basic device with snap-on lid), *Standard*

Type / WG03 / EL	Sensor / Output	Item No.	Price
TF43 PT100 xx	Pt100	IP 54	
TF43 Pt100 50mm	Pt100 (according to DIN EN 60 751, class B)	1101-7010-1013-000	24,93 €
TF43 Pt100 100mm	Pt100 (according to DIN EN 60 751, class B)	1101-7010-1023-000	25,04 €
TF43 Pt100 150mm	Pt100 (according to DIN EN 60 751, class B)	1101-7010-1033-000	25,83 €
TF43 Pt100 200mm	Pt100 (according to DIN EN 60 751, class B)	1101-7010-1043-000	26,56 €
TF43 Pt100 250mm	Pt100 (according to DIN EN 60 751, class B)	1101-7010-1053-000	27,91 €
TF43 Pt100 300mm	Pt100 (according to DIN EN 60 751, class B)	1101-7010-1063-000	30,20 €
TF43 Pt100 350mm	Pt100 (according to DIN EN 60 751, class B)	1101-7010-1073-000	31,13 €
TF43 Pt100 400mm	Pt100 (according to DIN EN 60 751, class B)	1101-7010-1083-000	32,12 €
TF43 PT1000 xx	Pt1000	IP 54	
TF43 Pt1000 50mm	Pt1000 (according to DIN EN 60 751, class B)	1101-7010-5011-000	24,93 €
TF43 Pt1000 100mm	Pt1000 (according to DIN EN 60 751, class B)	1101-7010-5021-000	25,04 €
TF43 Pt1000 150mm	Pt1000 (according to DIN EN 60 751, class B)	1101-7010-5031-000	25,83 €
TF43 Pt1000 200mm	Pt1000 (according to DIN EN 60 751, class B)	1101-7010-5041-000	26,56 €
TF43 Pt1000 250mm	Pt1000 (according to DIN EN 60 751, class B)	1101-7010-5051-000	27,91 €
TF43 Pt1000 300mm	Pt1000 (according to DIN EN 60 751, class B)	1101-7010-5061-000	30,20 €
TF43 Pt1000 350mm	Pt1000 (according to DIN EN 60 751, class B)	1101-7010-5071-000	31,13 €
TF43 Pt1000 400mm	Pt1000 (according to DIN EN 60 751, class B)	1101-7010-5081-000	32,12 €
TF43 PT1000A xx	Pt1000A	IP 54	
TF43 Pt1000A 50mm	Pt1000 (according to VDI/VDE 3512, class A-TGA)	1101-7010-6013-000	26,49 €
TF43 Pt1000A 100mm	Pt1000 (according to VDI/VDE 3512, class A-TGA)	1101-7010-6023-000	26,61 €
TF43 Pt1000A 150mm	Pt1000 (according to VDI/VDE 3512, class A-TGA)	1101-7010-6033-000	27,40 €
TF43 Pt1000A 200mm	Pt1000 (according to VDI/VDE 3512, class A-TGA)	1101-7010-6043-000	28,12 €
TF43 Pt1000A 250mm	Pt1000 (according to VDI/VDE 3512, class A-TGA)	1101-7010-6053-000	29,47 €
TF43 Pt1000A 300mm	Pt1000 (according to VDI/VDE 3512, class A-TGA)	1101-7010-6063-000	31,77 €
TF43 Pt1000A 350mm	Pt1000 (according to VDI/VDE 3512, class A-TGA)	1101-7010-6073-000	32,70 €
TF43 Pt1000A 400mm	Pt1000 (according to VDI/VDE 3512, class A-TGA)	1101-7010-6083-000	33,69 €
TF43 Ni1000 xx	Ni 1000	IP 54	
TF43 Ni1000 50mm	Ni1000 (according to DIN EN 43 760, class B, TCR = 6180 ppm/K)	1101-7010-9011-000	25,55 €
TF43 Ni1000 100mm	Ni1000 (according to DIN EN 43 760, class B, TCR = 6180 ppm/K)	1101-7010-9021-000	27,96 €
TF43 Ni1000 150mm	Ni1000 (according to DIN EN 43 760, class B, TCR = 6180 ppm/K)	1101-7010-9031-000	28,17 €
TF43 Ni1000 200mm	Ni1000 (according to DIN EN 43 760, class B, TCR = 6180 ppm/K)	1101-7010-9041-000	28,79 €
TF43 Ni1000 250mm	Ni1000 (according to DIN EN 43 760, class B, TCR = 6180 ppm/K)	1101-7010-9051-000	29,59 €
TF43 Ni1000 300mm	Ni1000 (according to DIN EN 43 760, class B, TCR = 6180 ppm/K)	1101-7010-9061-000	31,55 €
TF43 Ni1000 350mm	Ni1000 (according to DIN EN 43 760, class B, TCR = 6180 ppm/K)	1101-7010-9071-000	32,44 €
TF43 Ni1000 400mm	Ni1000 (according to DIN EN 43 760, class B, TCR = 6180 ppm/K)	1101-7010-9081-000	33,90 €
TF43 Ni1000TK xx	Ni1000 TK5000	IP 54	
TF43 NiTK 50mm	Ni1000 TK5000 (TCR = 5000 ppm/K), LG-Ni1000	1101-7011-0011-000	25,59 €
TF43 NiTK 100mm	Ni1000 TK5000 (TCR = 5000 ppm/K), LG-Ni1000	1101-7011-0021-000	28,02 €
TF43 NiTK 150mm	Ni1000 TK5000 (TCR = 5000 ppm/K), LG-Ni1000	1101-7011-0031-000	28,31 €
TF43 NiTK 200mm	Ni1000 TK5000 (TCR = 5000 ppm/K), LG-Ni1000	1101-7011-0041-000	28,91 €
TF43 NiTK 250mm	Ni1000 TK5000 (TCR = 5000 ppm/K), LG-Ni1000	1101-7011-0051-000	29,69 €
TF43 NiTK 300mm	Ni1000 TK5000 (TCR = 5000 ppm/K), LG-Ni1000	1101-7011-0061-000	31,67 €
TF43 NiTK 350mm	Ni1000 TK5000 (TCR = 5000 ppm/K), LG-Ni1000	1101-7011-0071-000	32,66 €
TF43 NiTK 400mm	Ni1000 TK5000 (TCR = 5000 ppm/K), LG-Ni1000	1101-7011-0081-000	34,02 €

Continued on next page...

High-performance encapsulation against
vibration, mechanical stress and humidity





THERMASGARD® TF 43 Temperature sensors (Basic device with snap-on lid), <i>Standard</i>			
Type/WG03/EL	Sensor/Output	Item No.	Price
TF43 LM235Z xx	LM235Z	IP54	
TF43 LM235Z 50mm	LM235Z (TCR = 10 mV / K; 2.73 V at 0 °C), KP10	1101-7012-1011-000	26,05 €
TF43 LM235Z 100mm	LM235Z (TCR = 10 mV / K; 2.73 V at 0 °C), KP10	1101-7012-1021-000	26,33 €
TF43 LM235Z 150mm	LM235Z (TCR = 10 mV / K; 2.73 V at 0 °C), KP10	1101-7012-1031-000	27,29 €
TF43 LM235Z 200mm	LM235Z (TCR = 10 mV / K; 2.73 V at 0 °C), KP10	1101-7012-1041-000	27,91 €
TF43 LM235Z 250mm	LM235Z (TCR = 10 mV / K; 2.73 V at 0 °C), KP10	1101-7012-1051-000	28,23 €
TF43 LM235Z 300mm	LM235Z (TCR = 10 mV / K; 2.73 V at 0 °C), KP10	1101-7012-1061-000	30,65 €
TF43 LM235Z 350mm	LM235Z (TCR = 10 mV / K; 2.73 V at 0 °C), KP10	1101-7012-1071-000	31,02 €
TF43 LM235Z 400mm	LM235Z (TCR = 10 mV / K; 2.73 V at 0 °C), KP10	1101-7012-1081-000	32,96 €
TF43 NTC 1.8K xx	NTC 1.8K	IP54	
TF43 NTC1,8K 50mm	NTC 1.8K	1101-7011-2011-000	24,93 €
TF43 NTC1,8K 100mm	NTC 1.8K	1101-7011-2021-000	26,28 €
TF43 NTC1,8K 150mm	NTC 1.8K	1101-7011-2031-000	26,94 €
TF43 NTC1,8K 200mm	NTC 1.8K	1101-7011-2041-000	27,57 €
TF43 NTC1,8K 250mm	NTC 1.8K	1101-7011-2051-000	28,91 €
TF43 NTC1,8K 300mm	NTC 1.8K	1101-7011-2061-000	29,86 €
TF43 NTC1,8K 350mm	NTC 1.8K	1101-7011-2071-000	30,87 €
TF43 NTC1,8K 400mm	NTC 1.8K	1101-7011-2081-000	31,67 €
TF43 NTC10K xx	NTC 10K	IP54	
TF43 NTC10K 50mm	NTC 10K	1101-7011-5011-000	24,93 €
TF43 NTC10K 100mm	NTC 10K	1101-7011-5021-000	26,28 €
TF43 NTC10K 150mm	NTC 10K	1101-7011-5031-000	26,94 €
TF43 NTC10K 200mm	NTC 10K	1101-7011-5041-000	27,57 €
TF43 NTC10K 250mm	NTC 10K	1101-7011-5051-000	28,91 €
TF43 NTC10K 300mm	NTC 10K	1101-7011-5061-000	29,86 €
TF43 NTC10K 350mm	NTC 10K	1101-7011-5071-000	30,87 €
TF43 NTC10K 400mm	NTC 10K	1101-7011-5081-000	31,67 €
TF43 NTC20K xx	NTC 20K	IP54	
TF43 NTC20K 50mm	NTC 20K	1101-7011-6011-000	24,93 €
TF43 NTC20K 100mm	NTC 20K	1101-7011-6021-000	26,28 €
TF43 NTC20K 150mm	NTC 20K	1101-7011-6031-000	26,94 €
TF43 NTC20K 200mm	NTC 20K	1101-7011-6041-000	27,57 €
TF43 NTC20K 250mm	NTC 20K	1101-7011-6051-000	28,91 €
TF43 NTC20K 300mm	NTC 20K	1101-7011-6061-000	29,86 €
TF43 NTC20K 350mm	NTC 20K	1101-7011-6071-000	30,87 €
TF43 NTC20K 400mm	NTC 20K	1101-7011-6081-000	31,67 €
Note	Other sensors optional	on request	
Optional:	Cable connection with M12 connector according to DIN EN 61076-2-101	on request	

TF43
with snap-on lid
(IP54)

Immersion / screw-in / duct temperature sensors
 with passive output

One basic device in four variants...



PATENTED

TFxx + TH08 -ms /xx

Immersion / screw-in temperature sensor with immersion sleeve, brass, nickel-plated

TFxx + TH08 -VA /xx

Immersion / screw-in temperature sensor with immersion sleeve, stainless steel, V4A

TFxx + TH08 -VA /xx /90

Immersion / screw-in temperature sensor with immersion sleeve with neck tube, stainless steel, V4A

TFxx + MF-15-K

Duct temperature sensor with mounting flange, plastic

Dimensional drawing TH08 -ms /xx

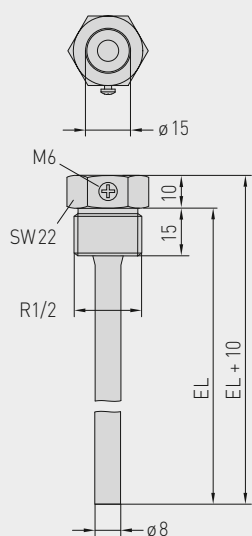

Dimensional drawing TH08 -VA /xx

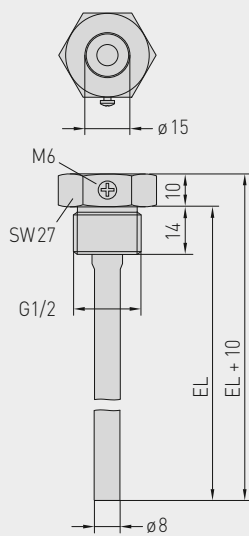

Dimensional drawing TH08 -VA /xx /90

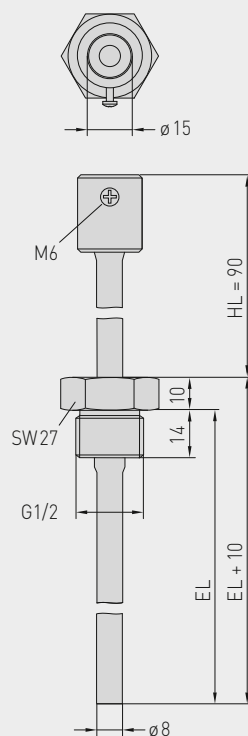

Dimensional drawing MF-15-K

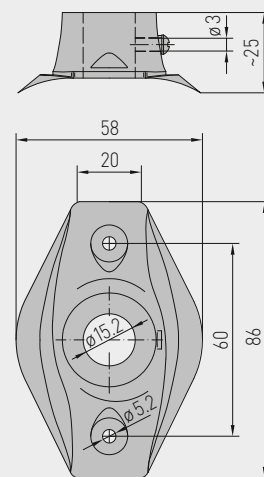



...through combination with accessories:



TH08-ms/xx
Immersion sleeve,
brass, nickel-plated,
thread-sealing, conical,
according to DIN 10226



TH08-VA/xx
Immersion sleeve,
stainless steel, V4A,
flat-sealing, cylindrical,
according to DIN 228



TH08-VA/xx/90
Immersion sleeve with neck tube,
stainless steel, V4A,
flat-sealing, cylindrical,
according to DIN 228



MF-15-K
Mounting flange,
plastic

THERMASGARD® TH08		Immersion sleeve Ø 8 mm (Accessories)			
Type / WG01B	p _{max} (static)	T _{max}	Inserted Length (EL)	Item No.	Price
TH08-ms/xx	Brass, nickel-plated			without neck tube	
TH08-MS 50MM	10 bar	+150 °C	50 mm	7100-0011-0010-132	8,21 €
TH08-MS 100MM	10 bar	+150 °C	100 mm	7100-0011-0020-132	9,35 €
TH08-MS 150MM	10 bar	+150 °C	150 mm	7100-0011-0030-132	9,88 €
TH08-MS 200MM	10 bar	+150 °C	200 mm	7100-0011-0040-132	10,19 €
TH08-MS 250MM	10 bar	+150 °C	250 mm	7100-0011-0050-132	11,81 €
TH08-MS 300MM	10 bar	+150 °C	300 mm	7100-0011-0060-132	12,13 €
TH08-MS 350MM	10 bar	+150 °C	350 mm	7100-0011-0070-132	12,23 €
TH08-MS 400MM	10 bar	+150 °C	400 mm	7100-0011-0080-132	12,34 €
TH08-VA/xx	Stainless steel, V4A (1.4571)			without neck tube	
TH08-VA 50MM	40 bar	+600 °C	50 mm	7100-0012-0010-132	17,88 €
TH08-VA 100MM	40 bar	+600 °C	100 mm	7100-0012-0020-132	19,76 €
TH08-VA 150MM	40 bar	+600 °C	150 mm	7100-0012-0030-132	21,23 €
TH08-VA 200MM	40 bar	+600 °C	200 mm	7100-0012-0040-132	22,38 €
TH08-VA 250MM	40 bar	+600 °C	250 mm	7100-0012-0050-132	27,82 €
TH08-VA 300MM	40 bar	+600 °C	300 mm	7100-0012-0060-132	29,07 €
TH08-VA 350MM	40 bar	+600 °C	350 mm	7100-0012-0070-132	29,27 €
TH08-VA 400MM	40 bar	+600 °C	400 mm	7100-0012-0080-132	29,79 €
TH08-VA/xx/90	Stainless steel, V4A (1.4571)			with neck tube (90 mm)	
TH08-VA 50/90MM	40 bar	+600 °C	50 mm	7100-0012-0012-132	25,61 €
TH08-VA 100/90MM	40 bar	+600 °C	100 mm	7100-0012-0022-132	26,76 €
TH08-VA 150/90MM	40 bar	+600 °C	150 mm	7100-0012-0032-132	28,07 €
TH08-VA 200/90MM	40 bar	+600 °C	200 mm	7100-0012-0042-132	29,27 €
TH08-VA 250/90MM	40 bar	+600 °C	250 mm	7100-0012-0052-132	30,68 €
TH08-VA 300/90MM	40 bar	+600 °C	300 mm	7100-0012-0062-132	33,25 €
Note:	inner diameter of socket 15.0 mm For further information see last chapter!				
Mounting flange (Accessories)					
Type / WG01B		T _{max}	Item No.	Price	
MF					
MF-15-K	Mounting flange, plastic, 56.8x84.3 mm, Ø 15.2 mm tube gland	+100 °C	7100-0032-0000-000	5,40 €	
Note:	For further information see last chapter!				