



Range 44 CE - Surface-mounting watertight junction boxes in compliance with EN 60670-1 (CEI 23-48) and IEC 60670-22 (CEI 23-94) and made in high-performance technopolymers. The range includes versions with protection degree IP44, IP55, IP56 with smooth walls or with quick entry cable glands and different type of covers: blind / transparent, deep/plain, press-on/screw (in plastic, also 1/4 turn, or in metal). Available in different self-extinguishing materials (up to GWT 960 °C). Suitable for ordinary junctions, for special uses, and for industrial uses.

Insulation class	II (according to IEC 61140 standards)	Colour	Grey RAL 7035
IP degree	IP56	Material	Technopolymer GWPLAST 120
Mechanical resistance	IK08	Internal dim. LxHxD (mm)	300x220x180
Max Ø holes possible	48 mm	Lid screws (no. and type)	4 insul. sealable hinged
Application	Industrial uses	Glow Wire Test	650 °C
Lid colour	Transparent	Lid	Deep screwed
Operating temperature	-25 +60 °C	Type of material	Halogen-free in compliance with EN 60754-2
Electrocod	0231	Thermo-pressure with ball	110 °C
Torque screws tightening	1.8 Newton/meter	Walls	Smooth
Accessories for insulation restoring	GW44621, GW44622		

#### BEHAVIOUR WITH CHEMICAL AND ATMOSPHERIC AGENTS

Saline solution	Acids		Bases		Solvents				Mineral oil	UV rays
	Concentrated	Diluted	Concentrated	Diluted	Hexane	Benzol	Acetone	Alcohol		
Resistant	Not resistant	Limited resistance	Not resistant	Limited resistance	Limited resistance	Not resistant	Not resistant	Limited resistance	Limited resistance	Limited resistance

#### DIMENSIONAL

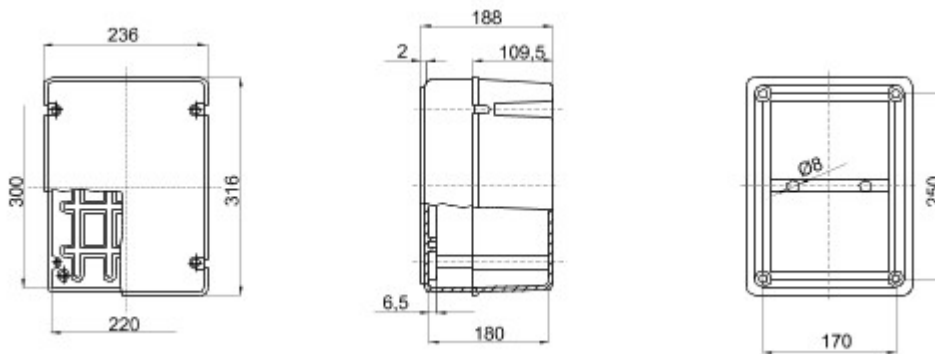

#### TECHNICAL SYMBOLOGY

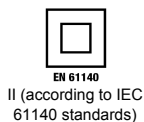

**IP**  
IP56

**IK**  
IK08

**GWT**  
650 °C



**HF**  
HALOGEN FREE  
Halogen-free in compliance with EN 60754-2

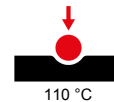

#### STANDARDS/APPROVALS

