

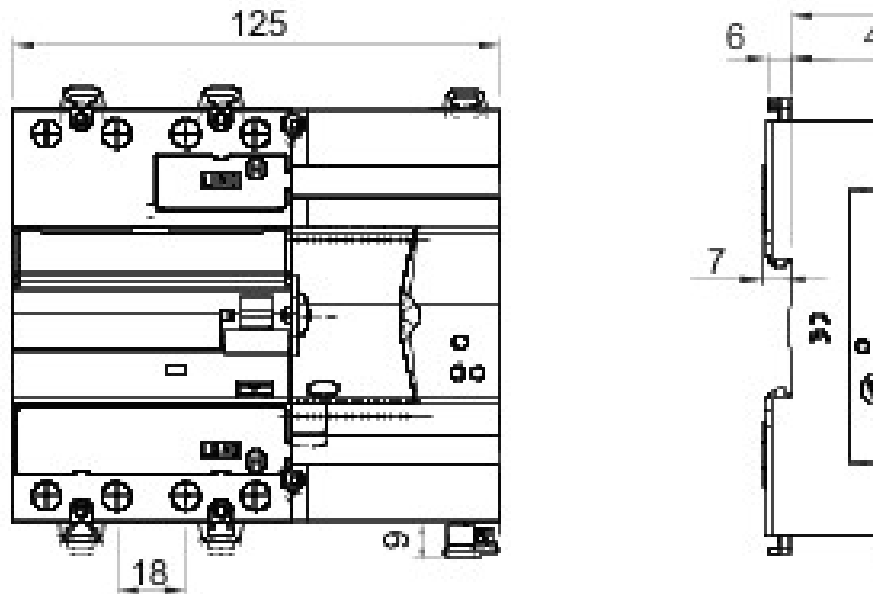

Description Automatic reclosing device  
 Code ReStart Autotest PRO 4P  
 Rated voltage AC 400 V  
 Rated current 40 A  
 No. modules 7  
 Standard EN 50557, EN 61008-1  
 Rated frequency (Hz) 50Hz  
 Distribution system TT - TN-S

Rated non-operating resistance between live parts and earth (Rdo)	8kΩ	Insulation voltage	500 V
Rated operating resistance between live parts and earth (Rd)	16 kΩ	Rated impulse withstand voltage	4 kV
Maximum operating frequency	30 oper./h	Overvoltage category	III
Mechanical endurance	4000	Dielectric strength test voltage between pole and earth	2500 Vac for 1 minute
Type of residual current protection	A[IR]	Rated residual operating current	30 mA
Operating temperature	-25 +60 °C	Stocking temperature	-40 +70 °C
Type of contacts	Photomos (potential free)	Voltage operating	5-230 V ac/dc
Current operating	0.6mA (min)-100mA cos=1 (max)	Operating frequency	50 Hz
Use category	AC12	Operating modes	NO/NC/NC + pulse
Rated tightening torque	0,4 Nm	Terminal section	≤ 2,5 mm <sup>2</sup>
Automatic reclosure for untimely tripping	Yes	Earth failure test	Yes
Continuous system monitoring	Yes	Autotest (automatic RCCB protection test)	Yes
Complete with	One device among: GW90954 Wi-Fi Module - GW90992 RS485 BUS Module	Number of poles	4P
Electrocod	1414	Compatibility with WiFi interface	Yes

### DIMENSIONAL



### STANDARDS/APPROVALS

