

# data SHEET

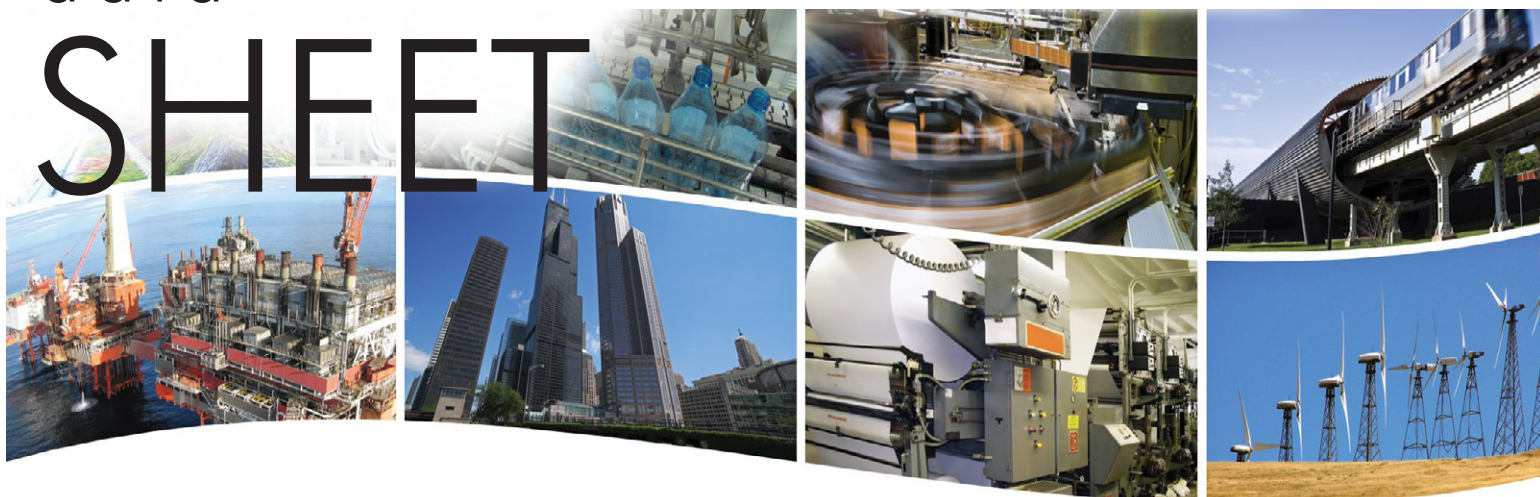

## 5-Port Skorpion Gigabit Diagnostic Switch Plug and Play Diagnostic Switch for Protocol Debugging

One benefit of switched Ethernet technology is that the switch restricts directed messages to only those ports party to the communication. This improves overall network throughput by not burdening end stations with useless traffic. However, this feature makes protocol debugging difficult because a protocol analyser tool attached to an unused port on the switch cannot observe any directed messages of interest. In the past, the solution was to change out the switching hub with a repeating hub but with the Skorpion Gigabit Diagnostic Switch this is unnecessary.

The EISK5-GT/H retains all the virtues of switched Ethernet technology such as 10/100/1000 Mbps data rates on individual segments, auto-negotiation,

Auto-MDIX — but with one exception: *no address learning*. All messages — directed, multicast, broadcast — are flooded to all ports on the switch allowing a protocol analyser tool such as Wireshark® the ability to observe all traffic on the network. The EISK5-GT/H can be permanently installed on an installation or replaced with a regular Skorpion switch once a system is commissioned.

This device can also be useful when developing embedded Ethernet devices because you can connect the Skorpion Gigabit Diagnostic Switch between two embedded Ethernet devices and view their messages using Wireshark.

- Plug-and-Play operation
- 10/100/1000 Mbps data rates
- Shielded RJ-45 connectors
- Auto-negotiation of speed and duplex
- Auto-MDIX supports cable inversion

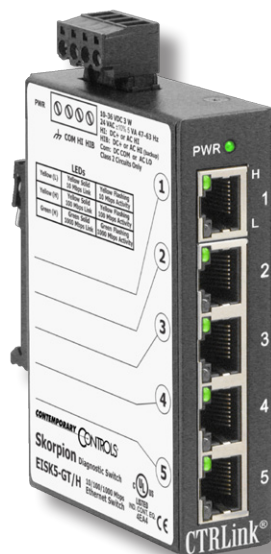

- DIN-rail mounting
- Rugged metal enclosure
- Diagnostic LEDs
- Enhanced EMC compliance
- UL 508 listed, c-UL listed, CE mark
- 24 VAC/VDC powered

Wireshark is a registered trademark of the Wireshark Foundation which can be accessed at [www.wireshark.org](http://www.wireshark.org).

## Overview

The EISK5-GT/H can be used for control panel installations where one needs the ability to diagnose problems in the field. It can also be used in a development environment when debugging code. A metal DIN-rail clip attached to the aluminium enclosure can survive the toughest installation. A writable side label allows the installer an opportunity to document field cabling locations right on the unit.

The EISK5-GT/H is powered from a source of either 24 VAC  $\pm 10\%$  or 10–36 VDC. With redundant power connections, a backup power

scheme can be supported. A removable power connector facilitates the servicing of the unit.

LEDs built into the RJ-45 connector indicate data rate and activity on each of the five ports. For each port, the data rate will be indicated along with port activity — thereby greatly assisting in troubleshooting connection issues.

The EISK5-GT/H is UL 508 Listed and c-UL Listed for Industrial Control Equipment. It complies with CFR 47 Part 15 Class A, and carries the CE Mark. It is RoHS compliant.

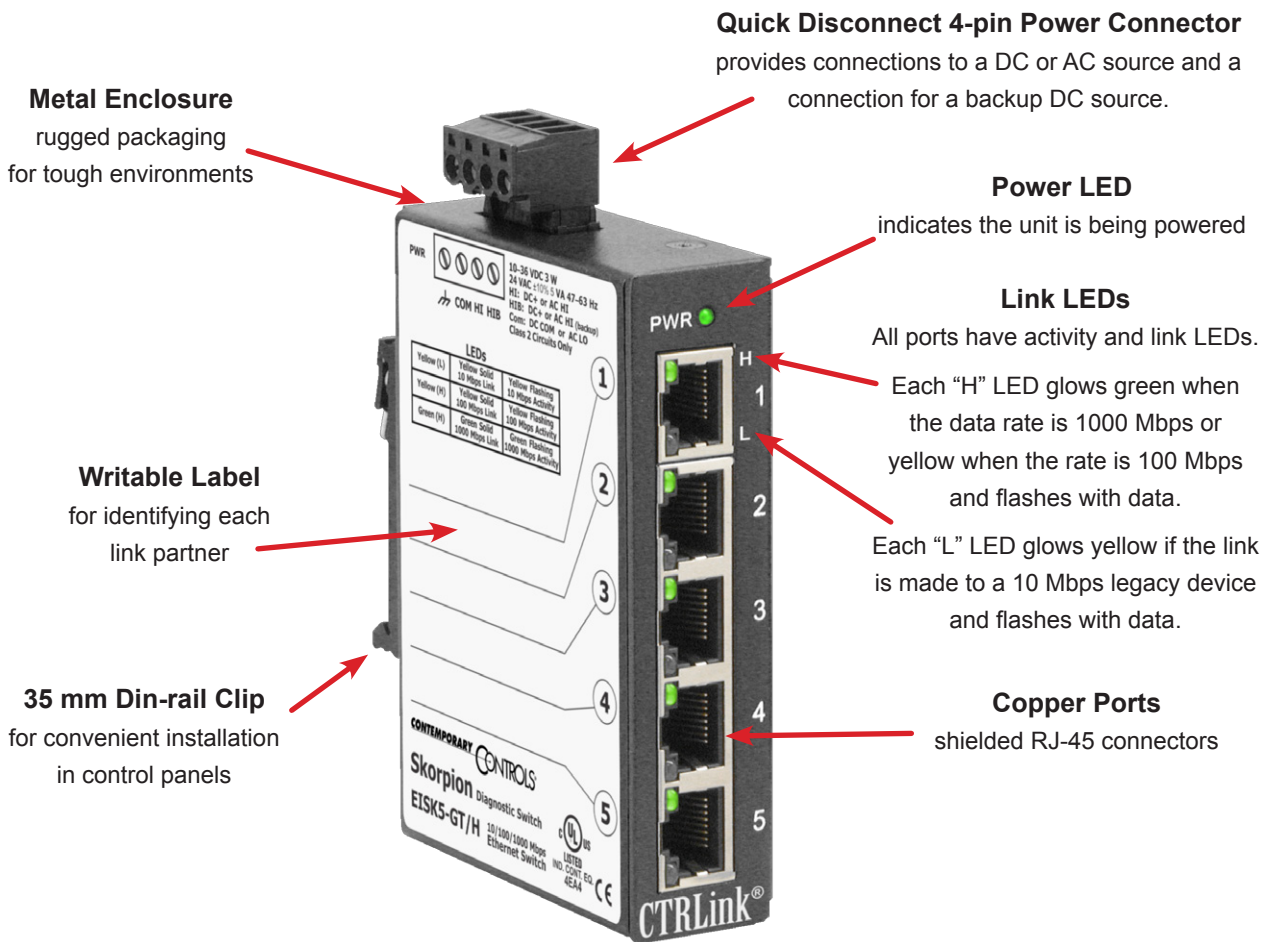

## Specifications

<b>Power Requirements</b>	10–36 VDC 3 W or 24 VAC ±10% 5 VA 47–63 Hz	
<b>Operating Temperature</b>	0°C to 60°C	
<b>Storage Temperature</b>	–40°C to 85°C	
<b>Relative Humidity</b>	10–95%, non-condensing	
<b>Protection</b>	IP30	
<b>Mounting</b>	TS-35 DIN-rail	
<b>Shipping Weight</b>	1 lb (0.45 kg)	
<b>Ethernet Communications</b>	IEEE 802.3 10/100/1000 Mbps data rate using RJ-45 connectors, 100 m (max) Supports jumbo frames up to 9216 bytes	
<b>LEDs</b>	Power “H” LEDs  “L” LEDs “H” or “L” LEDs	Green = power OK Green = 1000 Mbps communication established Yellow = 100 Mbps communication established Yellow = 10 Mbps communication established Flashing = data transmissions occurring

### Regulatory Compliance

CE Mark; CFR 47, Part 15 Class A; RoHS;  
UL 508 Industrial Control Equipment



### RJ-45 Connector Pin Assignments

Pin	Function
1	BI_DA+
2	BI_DA–
3	BI_DB+
4	BI_DC+
5	BI_DC–
6	BI_DB–
7	BI_DD+
8	BI_DD–

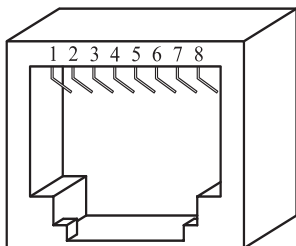

### Mechanical Drawing

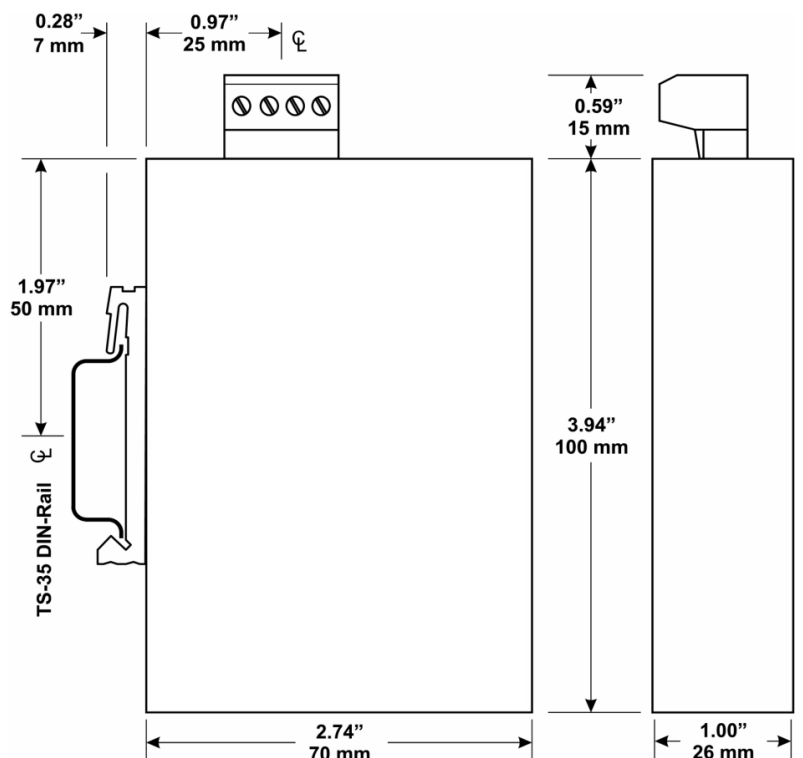

## Power Considerations

Applied voltage must be 10–36 VDC or 24 VAC  $\pm 10\%$  and deliver a current commensurate with power consumption. The recommended size for solid power conductors is 16–20 AWG; and for stranded conductors use 16–18 AWG. Zero volts (COM) is isolated from chassis (earth). Input connections are reverse-polarity protected.

Input power: 10–36 VDC or 24 VAC  $\pm 10\%$ , 47–60 Hz.  
Connecting chassis to earth or using a backup source is always optional.

All options shown are for use in Class 2 circuits if applied voltage is limited to 30V DC.

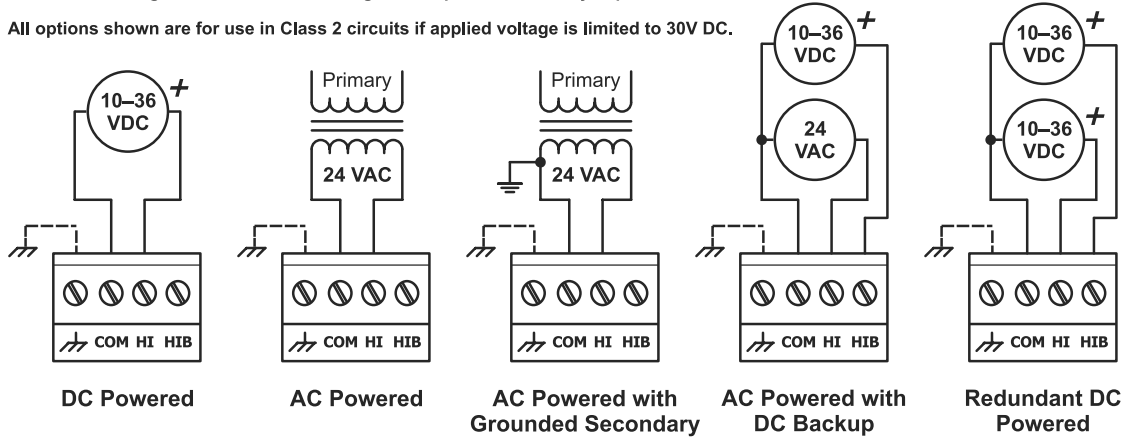

## Typical Installations

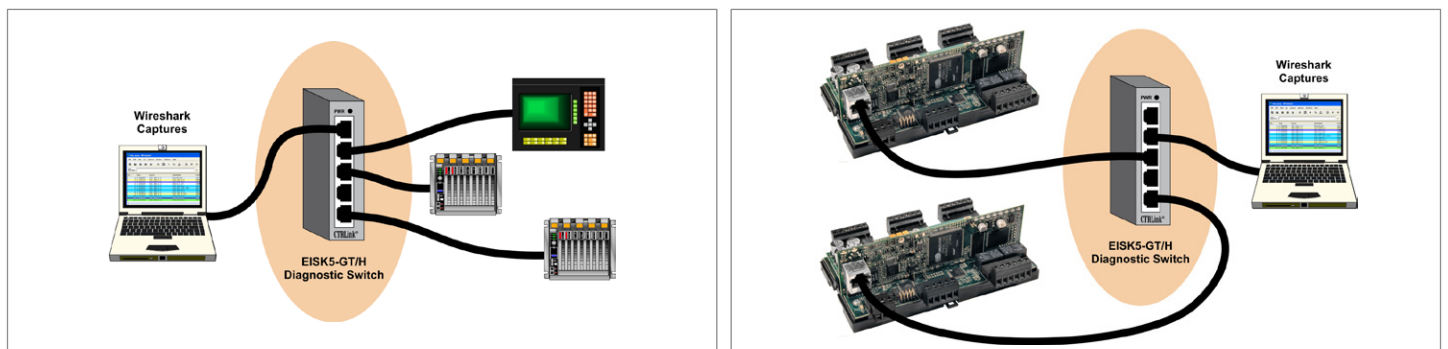

## Ordering Information

<i>Model</i>	<i>Description</i>
EISK5-GT/H	Skorpion 5-Port GigE Diagnostic Switch

### United States

Contemporary Control Systems, Inc.  
2431 Curtiss Street  
Downers Grove, IL 60515  
USA

Tel: +1 630 963 7070  
Fax: +1 630 963 0109

[info@ccontrols.com](mailto:info@ccontrols.com)  
[www.ccontrols.com](http://www.ccontrols.com)

### China

Contemporary Controls (Suzhou) Co. Ltd  
11 Huoju Road  
Science & Technology Industrial Park  
New District, Suzhou  
PR China 215009

Tel: +86 512 68095866  
Fax: +86 512 68093760

[info@ccontrols.com.cn](mailto:info@ccontrols.com.cn)  
[www.ccontrols.asia](http://www.ccontrols.asia)

### United Kingdom

Contemporary Controls Ltd  
14 Bow Court  
Fletchworth Gate  
Coventry CV5 6SP  
United Kingdom

Tel: +44 (0)24 7641 3786  
Fax: +44 (0)24 7641 3923

[info@ccontrols.co.uk](mailto:info@ccontrols.co.uk)  
[www.ccontrols.eu](http://www.ccontrols.eu)

### Germany

Contemporary Controls GmbH  
Fuggerstraße 1 B  
04158 Leipzig  
Germany

Tel: +49 341 520359 0  
Fax: +49 341 520359 16

[info@ccontrols.de](mailto:info@ccontrols.de)  
[www.ccontrols.eu](http://www.ccontrols.eu)