

# PCD1.G5010-A20

## E-Line RIO 12DI, 4Rel, 12AI, 8AO

### Starting with FW 1.08.xx

The L-Serie E-Line RIO modules are controlled via the RS-485 serial communication protocols S-Bus and Modbus for decentralised automation using industrial quality components. The data point mix is specifically designed for building automation applications.

The compact design according to DIN 43880 enables installation in electrical distribution boxes even in the most confined spaces. Installation and maintenance are facilitated by the local manual override for each output. Remote maintenance is also possible by accessing the manual override using the Saia PCD® controller's web interface. Programming is very efficient and fast using a complete FBox library with web templates for S-Bus. Individual programs may directly access the data points via Registers and Flags. Complete documentation is included in this data sheet.

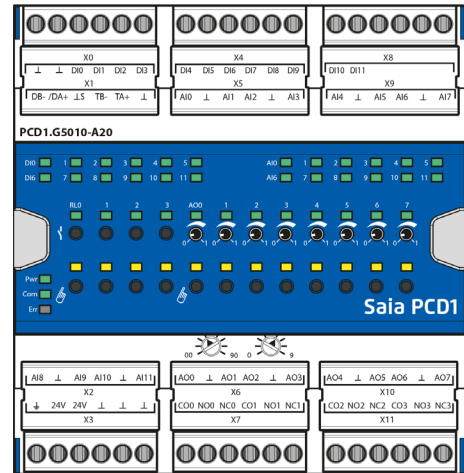

### Features

- S-Bus protocol optimized for fast data exchange
- Modbus protocol for integration in multi-vendor installations\*
- Local override operating level via web panel or buttons on the module
- Specific I/O mix suitable for HVAC systems
- Easy programming using the FBox library and web templates
- Industrial hardware in accordance with IEC EN 61131-2
- Pluggable terminal blocks protected by flaps
- Electrically isolated RS-485 interface

\* By default the module is working in S-Bus Data Mode with Autobaud detection. To configure Modbus the Windows-based application "E-LineApp" is required.

### General technical data

#### Power supply

Supply voltage	24 VDC, -15/+20% max. incl. 5% ripple (in accordance with EN/IEC 61131-2)
Electrically isolated	500 VDC between power supply and RS-485
Power consumption	1.2...3 W

#### Interfaces

Communications interface	RS-485 with electrically isolation Baud rate: 9,600, 19,200, 38,400, 57,600, 115,200 bps (Autobauding)
Address switch for S-Bus address	Two rotary switches 0...9 Address range 0...98
Terminating resistor	Integrated, can be activated via a wire jumper

#### General data

Ambient temperature	Operation: 0...+55 °C Storage: -40...+70 °C
---------------------	--

### Dimensions and installation

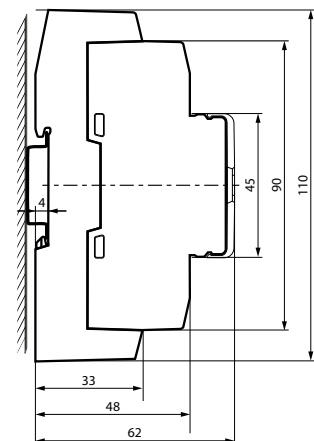
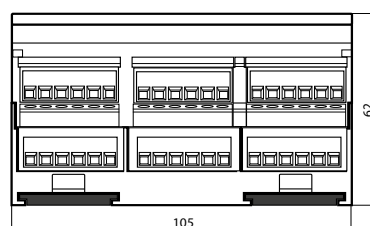
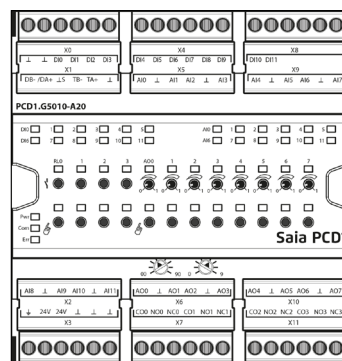

on a 35 mm top-hat rail (in accordance with DIN EN 60715 TH35)

Housing width 6 HP (105 mm)  
Compatible with electrical control cabinet (in accordance with DIN 43880, size 2 x 55 mm)



## Output configuration

### Relay outputs

Number	4 changeovers
Switching voltage max.	250 VAC / 30 VDC
Switching current max.	4 A (AC1, DC1)
Contact protection	None
Local manual override	Override operation by button

### Analogue outputs

Number	8	
Resolution	10 bit	
Signal range	0...10 V	
Local manual override	Manual control by button and potentiometer	
Protection	Short-circuit protection	
Resolution	9.77 mV	
Max. load at output	1 k $\Omega$ (10 mA at 10 V)	
Accuracy (at T <sub>Ambient</sub> = 25°C)	0.3% of the value +/- 10 mV	
Residual ripple	< 15 mVpp	
Temperature error (0°C...+55°C)	+/- 0.2%	
Output delay	Channel update	1 ms (all channels are updated in this time)
	Hardware output filter time	$\tau = 2.5$ ms

## Terminal technology

Push-in spring terminals enable wiring with rigid or flexible wires with a diameter up to 1.5 mm<sup>2</sup>. A max. of 1 mm<sup>2</sup> is permitted with cable end sleeves.

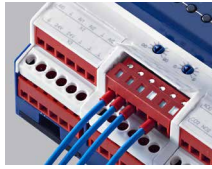

## Connection concept

The device is supplied by a 24 VDC voltage supply.

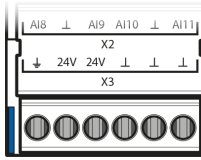

## Bus wiring

DB- and /DA+ terminals must be used for exchanging data between modules. The bus is through-wired by using one terminal per bus line in order to not interrupt the bus connection when removing the connector on modules.

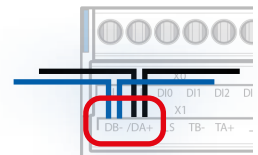

**i** Flexible RS-485 cables with a cross-section of no more than 0.75 mm<sup>2</sup> must be used for bus wiring. A total cross-section of 1.5 mm<sup>2</sup> is allowed per terminal.

The communication bus can be terminated with internal terminating resistors using wire bridges.

## Assignment overview

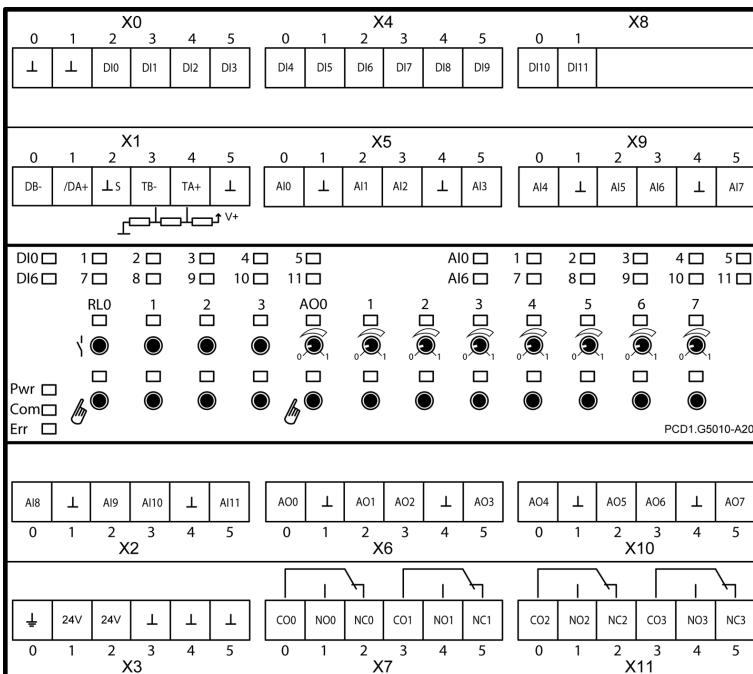

## Connection diagrams

### Digital input

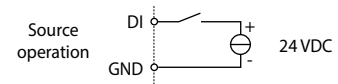

### Analogue input

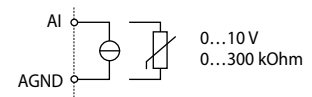

### Relay (changeover)

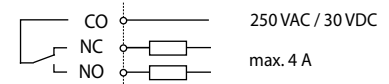

### Analogue output

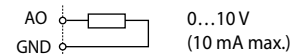

### Terminating resistor

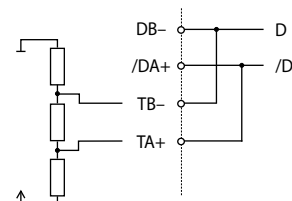

GND	┴	ground
GND	┴D	digital electrically isolated ground
GND	┴A	analogue electrically isolated ground
SGND	┴S	signal ground
	┴D#	# = alphanumeric index by different grounds



The modules are addressed and programmed with Saia PG5® Fupla FBoxes. Web templates are available for the operation and visualisation of the manual override function.

Fupla

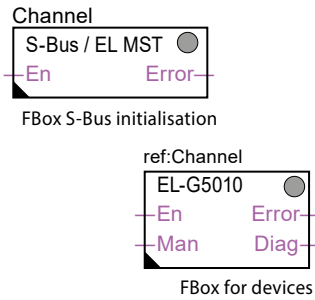
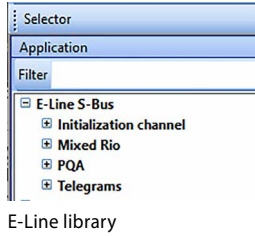

Communication FBox

- ▶ Data exchange for I/O via optimised S-Bus
- ▶ Configurable save state for bus interruption or timeout
- ▶ Direct generation of the symbols
- ▶ Reading and writing of the status of the manual override status
- ▶ Direct compatibility with web macros



Further information, including which FBoxes are supported, Getting Started, etc., can be found on our support page [www.sbc-support.com](http://www.sbc-support.com).

Web templates

Web templates are available for the operation and visualisation of the manual override function.

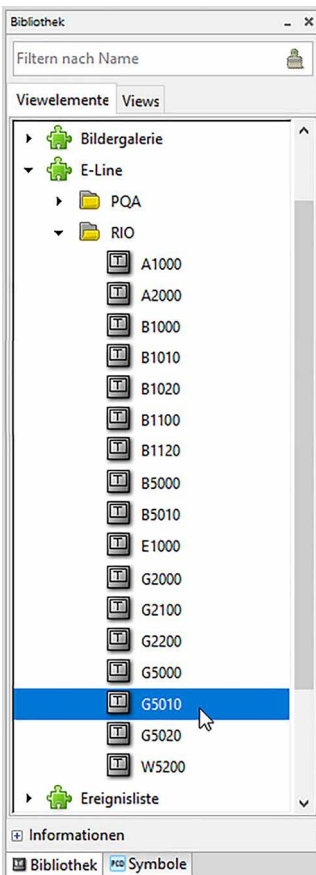

The inputs of the E-Line RIO modules can be addressed via the standard S-Bus. However the FBox from the E-Line library is used for the configuration of these modules. It is therefore recommended to use the optimised S-Bus protocol and the corresponding FBoxes from the E-Line library. Mixed mode operation is not recommended.

Manual operation



By using the local override function, commissioning can take place independently of the master station.

In addition, the manual operation can also be controlled remotely using a touch panel. If the bus line is cut off, the module keeps the manually set values. Traditional manual operation in the control cabinet door via potentiometers and switches can therefore be completely replaced by this solution.

Five operating modes can be selected for the manual operating function:

Operating modes	Description	Operation	
		at the module	via remote communication
1	Manual operation deactivated	✗	✗
2	Operation permitted from the module only	✓	✗
3	Operation permitted from the module and limited operation from the panel. If manual operation is activated at the module, it cannot be reset from the panel.	✓	(conditional)
4	Unlimited operation from the panel and module	✓	✓
5	Panel operation (remote)	✗	✓





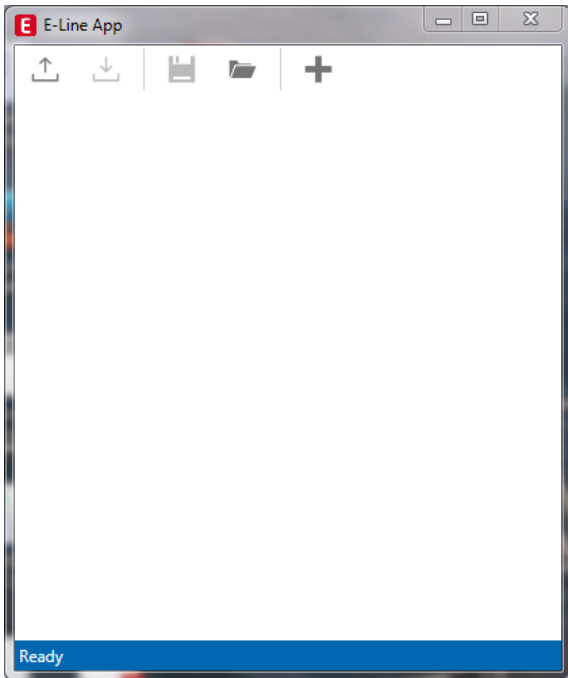

Depending on the application, reset of manually set values is allowed from a panel. To address this requirement, it is possible to deactivate or limit manual operation function.

## E-line App device setup

E-Line RIOs support the device setup by a windows application program connected via USB. The installer is available for download from the SBC support page: [www.sbc-support.com](http://www.sbc-support.com) → E-Line RIO IO Modules.



-  Create a new device configuration
-  Open an existing device configuration
-  Save the current settings as device configuration
-  Upload configuration from the device
-  Download settings to the device

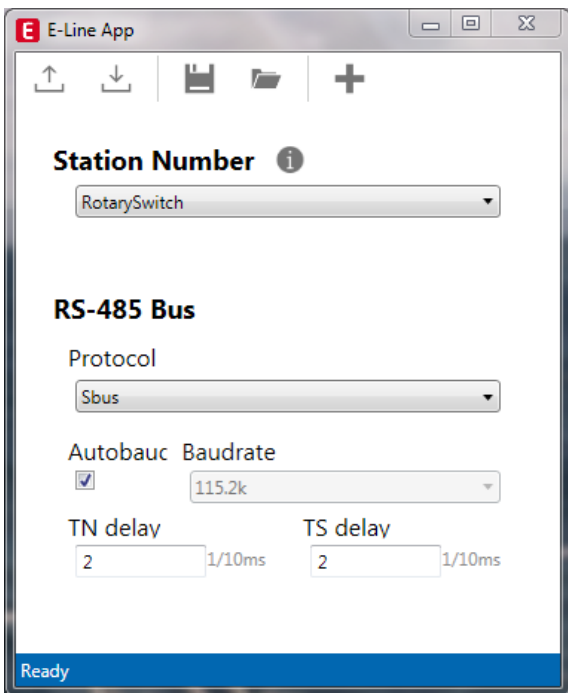

The station number can be set by the rotary switches at the device in the range of 0 ... 98. If the rotary switches are set to position 99 the station number can be defined by the device configuration in a range of 0 ... 253.

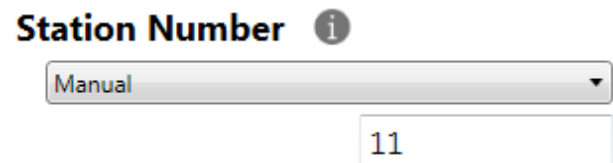

The serial communication protocol can be defined either as S-Bus or Modbus. By default the modules are delivered from factory with S-Bus.

### RS-485 Bus

Protocol

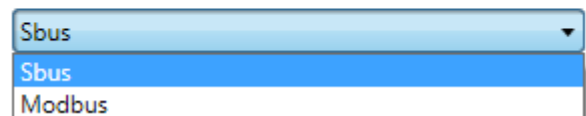

The Baudrate can be defined as automatic detection (default) or set to a specific value. The drop down choice will be available when the check box "Automatic" is unchecked. TN delay and TS delay shall be left at their default values of 2.

### S-Bus settings

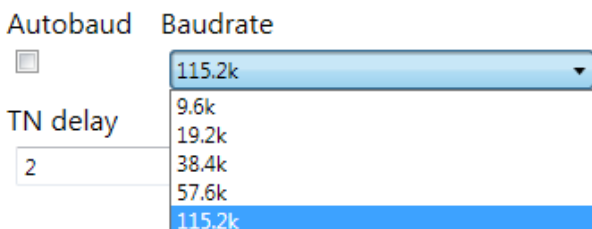

## Modbus settings

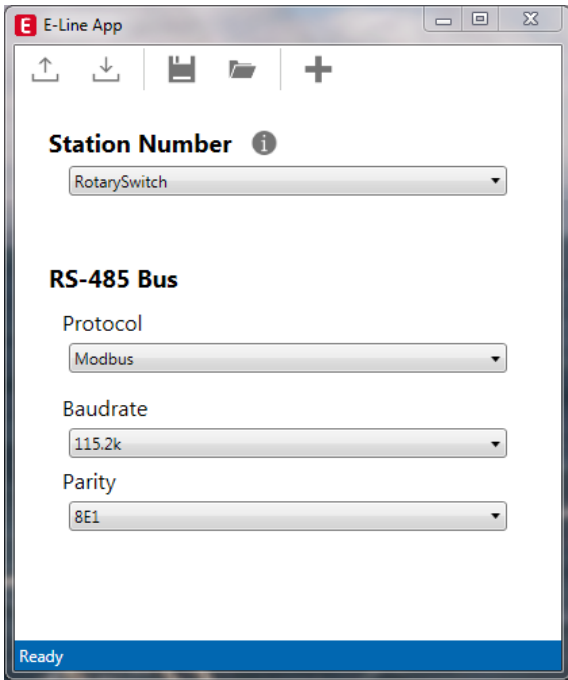

The Baudrate is set by default to 115 k. It can be defined as choice of the list.

### Baudrate

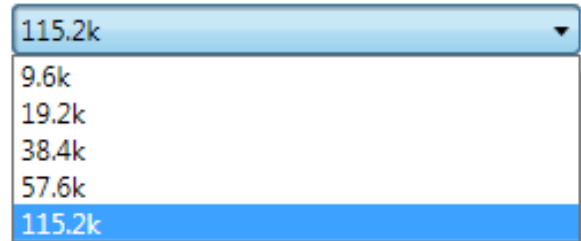

For best interoperability, the Parity Mode and number of Stop Bits can also be set.

### Parity

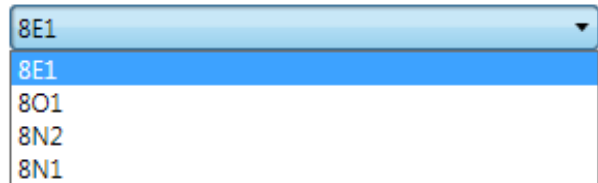

## S-Bus communication

S-Bus communication is based on Saia PCD® S-Bus Data Mode. Only the set-up of a unique S-Bus address within the communication line is required to establish a communication between Saia PCD® controllers and E-Line RIO modules. The address can be set using the rotary switches at the front of the module. The baud rate will be learned from the network by factory default. In addition a Windows-based application is available for manual parameter setup. Configuration parameters as well as manual override state and value are saved non-volatile. A delay of about one second between a manual state change and non-volatile saving has to be taken into consideration.

### Device address

- ▶ 0 ... 98 Address is taken from the rotary switches
- ▶ 99 Address is taken from the device configuration. The address is settable with the E-Line configuration software.

### Start-up procedure

- ▶ Reboot: All outputs are cleared (Off state)
- ▶ <1 sec. Output in manual operation are set according to the state before power down.
- ▶ Outputs in automatic mode

If, after reboot, no telegram is received within the "safe state power-on timeout," the module enters into the safe state mode and sets the outputs according to their configured values.

On reception of a valid command telegram the outputs are controlled by the communication. When no communication update follows within the "safe state com. timeout" the module enters into safe state and sets the outputs according to their configured values.

## Usage of the E-Line module-specific FBoxes

The usage of the E-Line module-specific FBoxes from the E-Line S-Bus Fupla library allows an easy and efficient commissioning of the E-Line RIO.

The FBox allows the definition and configuration of all possible functionalities of the E-Line RIO like manual override permission, usage of safe state mode, behaviour and colour of the LED's and so on.

In the background, the FBox uses the fast 'E-Line S-Bus' protocol for a high speed communication between the master and the RIO.

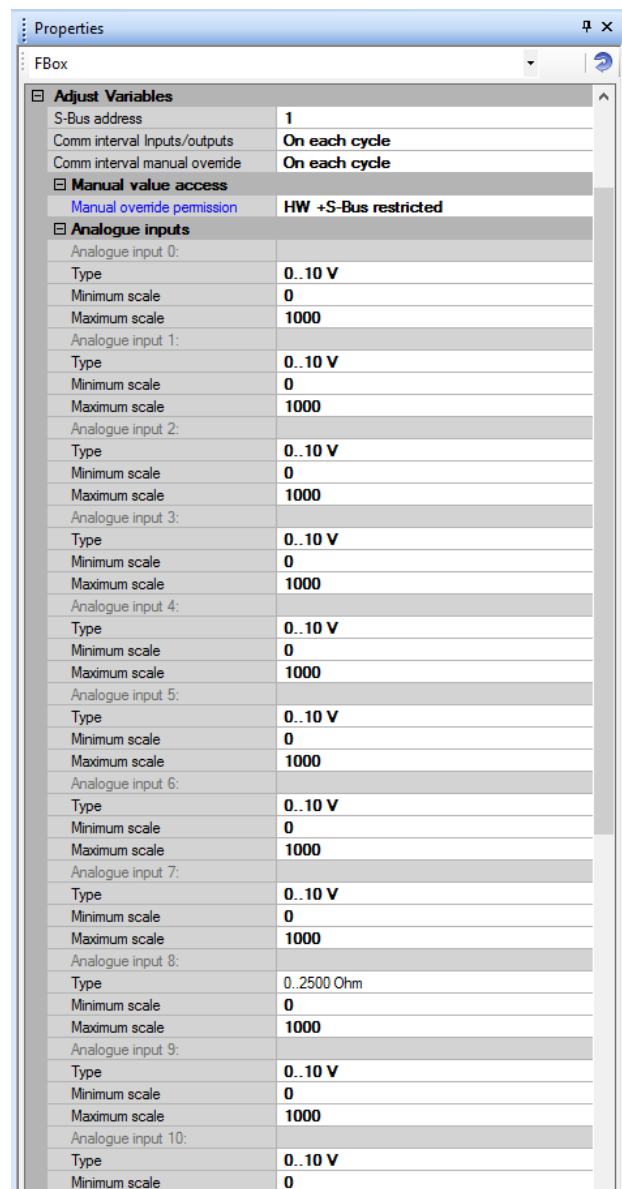
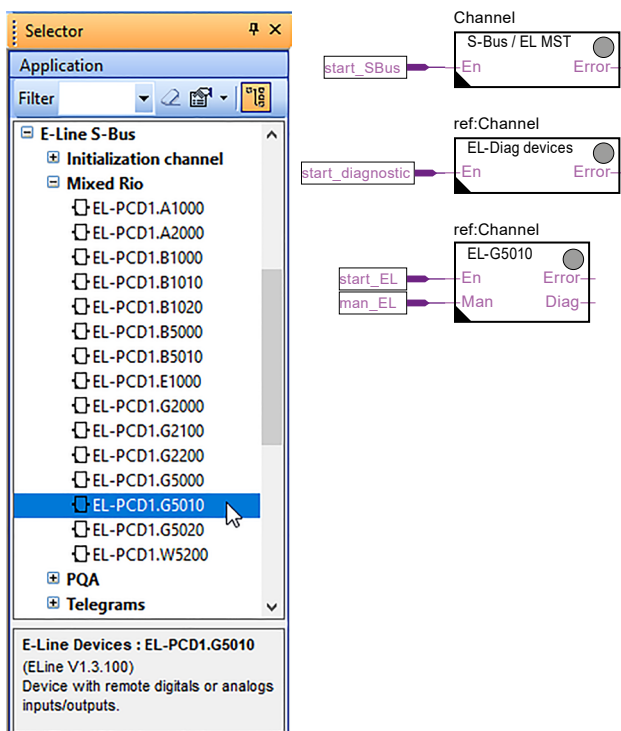



## S-Bus communication

### Direct access to the RIO media with standard S-Bus send and receive telegrams

The following chapter describes the media and parameter mapping to Registers and Flags for individual programming. For efficient PCD programming the E-Line RIO FBox family and templates are suitable for most applications. Only individual programming (e.g. Instruction List) requires standard S-Bus communication.

#### Digital inputs

Input	Input Value	Read/Write
Digital input 0	Flag 0	R
Digital input 1	Flag 1	R
...	Flag ...	R
Digital input 11	Flag 11	R

#### Analogue Inputs

Input	Input Value	Read/Write	Mode	Range Min	Range Max	Read/Write
Analogue Input 0	Register 0	R	Register 360	Register 380	Register 400	RW
Analogue Input 1	Register 1	R	Register 361	Register 381	Register 401	RW
Analogue Input 2	Register 2	R	Register 362	Register 382	Register 402	RW
Analogue Input 3	Register 3	R	Register 363	Register 383	Register 403	RW
Analogue Input 4	Register 4	R	Register 364	Register 384	Register 404	RW
Analogue Input 5	Register 5	R	Register 365	Register 385	Register 405	RW
Analogue Input 6	Register 6	R	Register 366	Register 386	Register 406	RW
Analogue Input 7	Register 7	R	Register 367	Register 387	Register 407	RW
Analogue Input 8	Register 8	R	Register 368	Register 388	Register 408	RW
Analogue Input 9	Register 9	R	Register 369	Register 389	Register 409	RW
Analogue Input 10	Register 10	R	Register 370	Register 390	Register 410	RW
Analogue Input 11	Register 11	R	Register 371	Register 391	Register 411	RW

\* Writable only if S-Bus permission is set in the configuration, otherwise write has no effect

\*\* Writing to these registers has no effect. Used only if hardware permission is set in the configuration

#### Mode Configuration Register:

0 : 0 ... 10 V (default)	Value scaled within Range Min and Range Max
3 : 0 ... 2500 Ω	Value scaled within Range Min and Range Max
4 : Pt1000	Value in 1/10°C (23.4 °C → 234)
5 : Ni1000	Value in 1/10°C (23.4 °C → 234)
6 : Ni1000LS	Value in 1/10°C (23.4 °C → 234)
8 : 0 ... 300 kΩ	Value scaled within Range Min and Range Max
9 : Digital input	Value for Input open, <5 V = 0, Input >10 V, 24 VDC = 1

Status	Status Value	Read/Write
Status AI0 ... AI3	Register 12	R
Status AI4 ... AI7	Register 13	R
Status AI8 ... AI11	Register 14	R

Register format:

1 byte for each analogue input status.

(e.g. byte 0: AI0

byte 1: AI1

byte 2: AI2

byte 3: AI3)

Bit 0 Analogue input over-range

Bit 1 Analogue input under-range

Status is cleared when the input returns to normal state

## S-Bus communication

### Relay outputs

Output	Output Value	Read/Write	Manual override Communication	Read/Write*	Manual override Local	Read/Write**
Relay output 0	Flag 30	RW	Register 28	RW	Register 40	RW
Relay output 1	Flag 31	RW	Register 29	RW	Register 41	RW
Relay output 2	Flag 32	RW	Register 30	RW	Register 42	RW
Relay output 3	Flag 33	RW	Register 31	RW	Register 43	RW

\* Writable only if S-Bus permission is set in the configuration, otherwise write has no effect

\*\*Writing to these registers has no effect. Used only if hardware permission is set in the configuration

### Analogue Outputs

Output	Output Value	Read/Write	Manual override Communication	Read/Write [1]	Manual override Local	Read/Write [2]
Analogue output 0	Register 20	RW	Register 32	RW	Register 44	RW
Analogue output 1	Register 21	RW	Register 33	RW	Register 45	RW
Analogue output 2	Register 22	RW	Register 34	RW	Register 46	RW
Analogue output 3	Register 23	RW	Register 35	RW	Register 47	RW
Analogue output 4	Register 24	RW	Register 36	RW	Register 48	RW
Analogue output 5	Register 25	RW	Register 37	RW	Register 49	RW
Analogue output 6	Register 26	RW	Register 38	RW	Register 50	RW
Analogue output 7	Register 27	RW	Register 39	RW	Register 51	RW

[1] Writable only if S-Bus permission is set in the configuration, otherwise write has no effect

[2] Writing to these registers has no effect. Used only if hardware permission is set in the configuration

Normal operation: The outputs are set according the flag set by the communication.

Manual operation: The output are set according to the manual command, the communication flags are ignored.

Safe State: In case of a broken communication, a safe state value can be applied, see table Safe State Configuration.

#### Register format for manual override via S-Bus (Reg. 28 ... 31, 32 ... 39):

Bit 0 Current output value

Bit 30 1: output is driven in manual override by S-Bus

Bit 31 1: output is driven in manual override by local push buttons

#### Register format for local manual override (Reg. 40 ... 43, 44 ... 51):

Bit 0 Current output value

Bit 31 1: output is driven in manual override by local push buttons

Output	Range Min	Range Max.	Read/Write
Analogue output 0	Register 440	Register 460	RW
Analogue output 1	Register 441	Register 461	RW
Analogue output 2	Register 442	Register 462	RW
Analogue output 3	Register 443	Register 463	RW
Analogue output 4	Register 444	Register 464	RW
Analogue output 5	Register 445	Register 465	RW
Analogue output 6	Register 446	Register 466	RW
Analogue output 7	Register 447	Register 467	RW

Output value 0...10 V == Register Value Range Min ... Range Max

## S-Bus communication

### Configuration for safe state and manual override

Output	Safe State Enable	Read/Write	Safe State Value	Read/Write
Relay output 0	Flag 320	RW	Flag 350	RW
Relay output 1	Flag 321	RW	Flag 351	RW
Relay output 2	Flag 322	RW	Flag 352	RW
Relay output 3	Flag 323	RW	Flag 353	RW
Analogue Output 0	Flag 300	RW	Flag 420	RW
Analogue Output 1	Flag 301	RW	Flag 421	RW
Analogue Output 2	Flag 302	RW	Flag 422	RW
Analogue Output 3	Flag 303	RW	Flag 423	RW
Analogue Output 4	Flag 304	RW	Flag 424	RW
Analogue Output 5	Flag 305	RW	Flag 425	RW
Analogue Output 6	Flag 306	RW	Flag 426	RW
Analogue Output 7	Flag 307	RW	Flag 427	RW
Communication safe state enable default 0 (disabled)			Flag 400	RW
Communication safe state timeout [ms] Valid values 1000 ... 100,000,000, default 15,000			Register 590	RW
Manual operation mode Bit 0: Disabled Bit 1: Remote control limited*, default 1 Bit 2: Local operation enabled, default 1 Bit 3: Remote control unlimited*, default 0 Bits can be combined to enable remote and local operation			Register 592	RW

\* If manual operation is locally activated at the module, the output value and manual state cannot be set/reset remotely

Manual operation mode:

- ▶ Disabled (0)
- ▶ Local operation only (4, Bit 2 set)
- ▶ Local operation enabled, remote limited (6, Bit 1 and 2 set), default
- ▶ Local and remote operation enabled (12, Bit 2 and 3 set)
- ▶ Remote operation only, local operation disabled (8, Bit 3 set)

The safe state enable flag and the safe state value are combined in the following way:

- Setting the enable flag to 0 keep the output value unchanged in case of safe state occurrence.
- Setting the enable flag to 1 writes the safe state value in case of safe state occurrence.

### Device Information

Firmware version (Decimal xyyzz, 10802 → 1.08.02)	Register 600	R
Number of supported registers	Register 601	R
Number of supported flags	Register 602	R
Product type (ASCII String)***	Register 605 ... 608	R
Hardware version (Hex)	Register 609	R
Serial number (Hex)	Register 611 ... 612	R
Communication protocol (1:S-Bus Slave, 3:Modbus)	Register 620	R
Communication baud rate	Register 621	R
Communication auto baud enable (0:disabled, 1:enabled)	Register 622	R
Communication TN delay *	Register 623	R
Communication TS delay **	Register 624	R
Communication module address	Register 626	R

\* Time in 0.1 ms (e.g. 2 means 200 us) before setting activation of RS-485 line driver send mode (only used for S-Bus slave protocol)

\*\* Time in 0.1 ms (e.g. 2 means 200 us) before sending the first character after line driver activation (only used for S-Bus slave protocol)

\*\*\* The four registers contain the ASCII characters of the product type.

E.g. for PCD1.A2000-A20:

0605: 50434431H      0606: 2E413230H      0607: 30302D41H      0608: 32300000H

## Modbus communication

---

Modbus fulfils the requirements for standard communication protocols. It is based on Modbus RTU. The Windows-based configuration software is required to enable and set up the Modbus communication parameters. The device address can be set up with the rotary switches at the front of the module. Configuration parameters as well as manual override state and value are saved non-volatile. A delay of about one second between a manual state change and non-volatile saving has to be taken into consideration.

### Device address

- ▶ 0 ... 98 Address is taken from the rotary switches
- ▶ 99 Address is taken from the device configuration. The address is settable with the E-Line configuration software.

### Start-up procedure

- ▶ Reboot: All outputs are cleared (Off state)
- ▶ <1 sec. Output in manual operation are set according to the state before power down.
- ▶ Outputs in automatic mode  
If, after reboot, no telegram is received within the "safe state power-on timeout," the module enters into the safe state mode and sets the outputs according to their configured values.  
On reception of a valid command telegram the outputs are controlled by the communication. When no communication update follows within the "safe state com. timeout" the module enters into safe state and sets the outputs according to their configured values.

The following chapter describes the media and parameter mapping to Registers and Flags (=Coils).

### Supported Modbus services:

- ▶ Function code 1 (read coils (outputs))
- ▶ Function code 3 (read registers)
- ▶ Function code 15 (write multiple coils (outputs))
- ▶ Function code 16 (write multiple registers)

### Read coils

Request							
Address	Function	Start Address		Number of coils to read		CRC	
0 ... 254	1	High-Byte	Low-Byte	High-Byte	Low-Byte	High-Byte	Low-Byte

Reply							
Address	Function	No. of Byte	Data			CRC	
0 ... 254	1	0 ... 256	Coil 0 ... 7	Coil 8 ... 15	...	High-Byte	Low-Byte

### Write coils

Request										
Address	Function	Start Address		Number of Coils to write		Coil data			CRC	
0 ... 254	15	High-Byte	Low-Byte	High-Byte	Low-Byte	No. of Bytes	Coil 0 ... 7	...	High-Byte	Low-Byte

Reply							
Address	Function	Start Address		Number of written Coils		CRC	
0 ... 254	15	High-Byte	Low-Byte	High-Byte	Low-Byte	High-Byte	Low-Byte

### Read register

Request							
Address	Function	Start Address		No. of Register to read		CRC	
0 ... 254	3	High-Byte	Low-Byte	High-Byte	Low-Byte	High-Byte	Low-Byte

Reply							
Address	Function	No. of Byte	Register Start Addr + 0	Addr + n	CRC		
0 ... 254	3	0 ... 256	High-Byte	Low-Byte	...	High-Byte	Low-Byte

### Write register

Request											
Address	Function	Start Address		No. of Registers		No. of Bytes	Data Word: Start Addr + 0	Addr + n	CRC		
0 ... 254	16	High-Byte	Low-Byte	High-Byte	Low-Byte	2 ... 256	Low-Byte	High-Byte	...	High-Byte	Low-Byte

Reply							
Address	Function	Start Address		No of written Registers		CRC	
0 ... 254	16	High-Byte	Low-Byte	High-Byte	Low-Byte	High-Byte	Low-Byte

The CRC has to be calculated over all telegram bytes starting with address field up to the last data byte. The CRC has to be attached to the data. Please find an example at the appendix of this document. For more details, please refer the publicly available Modbus documentation [www.modbus.org](http://www.modbus.org).

## Modbus communication

### Digital inputs

Input	Input Value	Read/Write
Digital input 0	Coil 0	R
Digital input 1	Coil 1	R
...	Coil ...	R
Digital input 11	Coil 11	R

### Analogue inputs

Input	Input Value	Read/Write	Mode	Range Min	Range Max	Read/Write
Analogue Input 0	Register 0-1	R	Register 720-721	Register 760-761	Register 800-801	RW
Analogue Input 1	Register 2-3	R	Register 722-723	Register 762-763	Register 802-803	RW
Analogue Input 2	Register 4-5	R	Register 724-725	Register 764-765	Register 804-805	RW
Analogue Input 3	Register 6-7	R	Register 726-727	Register 766-767	Register 806-807	RW
Analogue Input 4	Register 8-9	R	Register 728-729	Register 768-769	Register 808-809	RW
Analogue Input 5	Register 10-11	R	Register 730-731	Register 770-771	Register 810-811	RW
Analogue Input 6	Register 12-13	R	Register 732-733	Register 772-773	Register 812-813	RW
Analogue Input 7	Register 14-15	R	Register 734-735	Register 774-775	Register 814-815	RW
Analogue Input 8	Register 16-17	R	Register 736-737	Register 776-777	Register 816-817	RW
Analogue Input 9	Register 18-19	R	Register 738-739	Register 778-779	Register 818-819	RW
Analogue Input 10	Register 20-21	R	Register 740-741	Register 780-781	Register 820-821	RW
Analogue Input 11	Register 22-23	R	Register 742-743	Register 782-783	Register 822-823	RW

\* Writable only if Modbus permission is set in the configuration, otherwise write has no effect

\*\*Writing to these registers has no effect. Used only if hardware permission is set in the configuration

### Mode Configuration Register:

0 : 0 ... 10 V (default)	Value scaled within Range Min and Range Max
3 : 0 ... 2500 Ω	Value scaled within Range Min and Range Max
4 : Pt1000	Value in 1/10°C (23.4 °C → 234)
5 : Ni1000	Value in 1/10°C (23.4 °C → 234)
6 : Ni1000LS	Value in 1/10°C (23.4 °C → 234)
8 : 0 ... 300 kΩ	Value scaled within Range Min and Range Max
9 : Digital input	Value for Input open, <5 V = 0, Input >10 V, 24 VDC = 1

Status	Status Value	Read/Write
Status AI0 ... AI3	Register 24-25	R
Status AI4 ... AI7	Register 26-27	R
Status AI8 ... AI11	Register 28-29	R

Register format:

1 byte for each analogue input status.

(e.g. byte 0: AI0

byte 1: AI1

byte 2: AI2

byte 3: AI3)

Bit 0 Analogue input over-range

Bit 1 Analogue input under-range

Status is cleared when the input has again a correct value.

## Modbus communication

### Relay outputs Digital outputs

Output	Output Value	Read/Write	Manual override Communication	Read/Write*	Manual override Local	Read/Write**
Relay output 0	Coil 30	RW	Value Reg. 56 Enable Reg. 57	RW	Value Reg. 80 Enable Reg. 81	RW
Relay output 1	Coil 31	RW	Value Reg. 58 Enable Reg. 59	RW	Value Reg. 82 Enable Reg. 83	RW
Relay output 2	Coil 32	RW	Value Reg. 60 Enable Reg. 61	RW	Value Reg. 84 Enable Reg. 85	RW
Relay output 3	Coil 33	RW	Value Reg. 62 Enable Reg. 63	RW	Value Reg. 86 Enable Reg. 87	RW

\* Writable only if Modbus permission is set in the configuration, otherwise write has no effect

\*\*Writing to these registers has no effect. Used only if hardware permission is set in the configuration

### Analogue Outputs

Output	Output Value	Read/Write	Manual override Communication	Read/Write [1]	Manual override Local	Read/Write [2]
Analogue output 0	Register 40-41	RW	Value Reg. 64 Enable Reg. 65	RW	Value Reg. 88 Enable Reg. 89	RW
Analogue output 1	Register 42-43	RW	Value Reg. 66 Enable Reg. 67	RW	Value Reg. 90 Enable Reg. 91	RW
Analogue output 2	Register 44-45	RW	Value Reg. 68 Enable Reg. 69	RW	Value Reg. 92 Enable Reg. 93	RW
Analogue output 3	Register 46-47	RW	Value Reg. 70 Enable Reg. 71	RW	Value Reg. 94 Enable Reg. 95	RW
Analogue output 4	Register 48-49	RW	Value Reg. 72 Enable Reg. 73	RW	Value Reg. 96 Enable Reg. 97	RW
Analogue output 5	Register 50-51	RW	Value Reg. 74 Enable Reg. 75	RW	Value Reg. 98 Enable Reg. 99	RW
Analogue output 6	Register 52-53	RW	Value Reg. 76 Enable Reg. 77	RW	Value Reg. 100 Enable Reg. 101	RW
Analogue output 7	Register 54-55	RW	Value Reg. 78 Enable Reg. 79	RW	Value Reg. 102 Enable Reg. 103	RW

[1] Writable only if Modbus permission is set in the configuration, otherwise write has no effect

[2] Writing to these registers has no effect. Used only if hardware permission is set in the configuration

Normal operation: The outputs are set according the flag set by the communication.

Manual operation: The output are set according to the manual command, the communication flags are ignored.

Safe State: In case of a broken communication, a safe state value can be applied, see table Safe State Configuration.

#### Register format for manual override via Modbus (Reg. 48 ... 63, 64 ... 71):

Bit 0 Current output value

Enable Reg. Bit 14 1: output is driven in manual override by Modbus

Enable Reg. Bit 15 1: output is driven in manual override by local push buttons

#### Register format for local manual override (Reg. 72 ... 87, 88 ... 95):

Value Reg. Bit 0 Current output value

Enable Reg. Bit 15 1: output is driven in manual override by local push buttons

Output	Range Min	Range Max.	Read/Write
Analogue output 0	Register 880-881	Register 920-921	RW
Analogue output 1	Register 882-883	Register 922-923	RW
Analogue output 2	Register 884-885	Register 924-925	RW
Analogue output 3	Register 886-887	Register 926-927	RW
Analogue output 4	Register 888-889	Register 928-929	RW
Analogue output 5	Register 890-891	Register 930-931	RW
Analogue output 6	Register 892-893	Register 932-933	RW
Analogue output 7	Register 894-895	Register 934-935	RW

Output value 0...10 V == Register Value Range Min ... Range Max

## Modbus communication

### Configuration for safe state and manual override

Output	Safe State Enable	Read/Write	Safe State Value	Read/Write
Relay output 0	Coil 320	RW	Coil 350	RW
Relay output 1	Coil 321	RW	Coil 351	RW
Relay output 2	Coil 322	RW	Coil 352	RW
Relay output 3	Coil 323	RW	Coil 353	RW
Analogue Output 0	Coil 300	RW	Register 840-841	RW
Analogue Output 1	Coil 301	RW	Register 842-843	RW
Analogue Output 2	Coil 302	RW	Register 844-845	RW
Analogue Output 3	Coil 303	RW	Register 846-847	RW
Analogue Output 4	Coil 304	RW	Register 848-849	RW
Analogue Output 5	Coil 305	RW	Register 850-851	RW
Analogue Output 6	Coil 306	RW	Register 852-853	RW
Analogue Output 7	Coil 307	RW	Register 854-855	RW
Communication safe state enable default 0 (disabled)			Coil 400	RW
Communication safe state timeout [ms] Valid values 1000 ... 100,000,000, default 15,000			Reg. 1180, 1181	RW
Manual operation mode Bit 0: Disabled Bit 1: Remote control limited*, default 1 Bit 2: Local operation enabled, default 1 Bit 3: Remote control unlimited*, default 0 Bits can be combined to enable remote and local operation			Register 1184	RW

\* If manual operation is locally activated at the module, the output value and manual state cannot be set/reset remotely

Manual operation mode:

- ▶ Disabled (0)
- ▶ Local operation only (4, Bit 2 set)
- ▶ Local operation enabled, remote limited (6, Bit 1 and 2 set), default
- ▶ Local and remote operation enabled (12, Bit 2 and 3 set)
- ▶ Remote operation only, local operation disabled (8, Bit 3 set)

The safe state enable flag and the safe state value are combined in the following way:

- Setting the enable flag to 0 keep the output value unchanged in case of safe state occurrence.
- Setting the enable flag to 1 writes the safe state value in case of safe state occurrence.

### Device Information

Firmware version (Decimal xyzzyz, 10802 → 1.08.02)	Register 1200	R
Number of supported registers	Register 1202	R
Number of supported flags	Register 1204	R
Product type (ASCII String)*	Register 1210 ... 1217	R
Hardware version (Hex)	Register 1218	R
Serial number (Hex)	Register 1222 ... 1224	R
Communication protocol (1: S-Bus Slave, 3: Modbus)	Register 1240	R
Communication baud rate	Register 1242	R
Communication auto baud enable (0:disabled, 1:enabled)	Register 1244	R
Communication Mode 0: 8,E,1;            1: 8,O,1;            2: 8,N,2;            3: 8,N,1	Register 1250	R
Communication module address	Register 1252	R

\* The eight registers contain the ASCII characters of the product type.  
E.g. for PCD1.A2000-A20:  
1210...1217: 5043H | 4431H | 2E41H | 3230H | 3030H | 2D41H | 3230H | 0000H



### CRC Generation Example

(Source: [http://modbus.org/docs/PI\\_MBUS\\_300.pdf](http://modbus.org/docs/PI_MBUS_300.pdf), the following content of this page is copied from the referenced document. In case of any questions, please check out the original source)

The function takes two arguments: unsigned char \*puchMsg; A pointer to the message buffer containing binary data to be used for generating the CRC unsigned short usDataLen; The quantity of bytes in the message buffer. The function returns the CRC as a type unsigned short.

### CRC Generation Function

```
unsigned short CRC16(puchMsg, usDataLen) ;
unsigned char *puchMsg ;                               /* message to calculate CRC upon */
unsigned short usDataLen ;                             /* quantity of bytes in message */
{
    unsigned char uchCRCHi = 0xFF ;                   /* high byte of CRC initialized */
    unsigned char uchCRCLo = 0xFF ;                   /* low byte of CRC initialized */
    unsigned uIndex ;                                  /* will index into CRC lookup table */
    while (usDataLen--)>0                             /* pass through message buffer */
    {
        uIndex = uchCRCHi ^ *puchMsgg++;             /* calculate the CRC */
        uchCRCHi = uchCRCLo ^ auchCRCHi[uIndex];
        uchCRCLo = auchCRCLo[uIndex];
    }
    return (uchCRCHi << 8 | uchCRCLo);
}
```

### High-Order Byte Table

```
/* Table of CRC values for high-order byte */
static unsigned char auchCRCHi[] = {
0x00, 0xC1, 0x81, 0x40, 0x01, 0xC0, 0x80, 0x41, 0x01, 0xC0, 0x80, 0x41, 0x00, 0xC1, 0x81, 0x40,
0x01, 0xC0, 0x80, 0x41, 0x00, 0xC1, 0x81, 0x40, 0x00, 0xC1, 0x81, 0x40, 0x01, 0xC0, 0x80, 0x41,
0x01, 0xC0, 0x80, 0x41, 0x00, 0xC1, 0x81, 0x40, 0x00, 0xC1, 0x81, 0x40, 0x01, 0xC0, 0x80, 0x41,
0x00, 0xC1, 0x81, 0x40, 0x01, 0xC0, 0x80, 0x41, 0x01, 0xC0, 0x80, 0x41, 0x00, 0xC1, 0x81, 0x40,
0x01, 0xC0, 0x80, 0x41, 0x00, 0xC1, 0x81, 0x40, 0x01, 0xC0, 0x80, 0x41, 0x01, 0xC0, 0x80, 0x41,
0x00, 0xC1, 0x81, 0x40, 0x01, 0xC0, 0x80, 0x41, 0x01, 0xC0, 0x80, 0x41, 0x00, 0xC1, 0x81, 0x40,
0x01, 0xC0, 0x80, 0x41, 0x00, 0xC1, 0x81, 0x40, 0x00, 0xC1, 0x81, 0x40, 0x01, 0xC0, 0x80, 0x41,
0x01, 0xC0, 0x80, 0x41, 0x00, 0xC1, 0x81, 0x40, 0x00, 0xC1, 0x81, 0x40, 0x01, 0xC0, 0x80, 0x41,
0x01, 0xC0, 0x80, 0x41, 0x00, 0xC1, 0x81, 0x40, 0x01, 0xC0, 0x80, 0x41, 0x01, 0xC0, 0x80, 0x41,
0x00, 0xC1, 0x81, 0x40, 0x01, 0xC0, 0x80, 0x41, 0x01, 0xC0, 0x80, 0x41, 0x00, 0xC1, 0x81, 0x40,
0x01, 0xC0, 0x80, 0x41, 0x00, 0xC1, 0x81, 0x40, 0x01, 0xC0, 0x80, 0x41, 0x01, 0xC0, 0x80, 0x41,
0x00, 0xC1, 0x81, 0x40, 0x01, 0xC0, 0x80, 0x41, 0x01, 0xC0, 0x80, 0x41, 0x00, 0xC1, 0x81, 0x40,
0x01, 0xC0, 0x80, 0x41, 0x00, 0xC1, 0x81, 0x40, 0x00, 0xC1, 0x81, 0x40, 0x01, 0xC0, 0x80, 0x41,
0x01, 0xC0, 0x80, 0x41, 0x00, 0xC1, 0x81, 0x40, 0x01, 0xC0, 0x80, 0x41, 0x01, 0xC0, 0x80, 0x41,
0x00, 0xC1, 0x81, 0x40, 0x01, 0xC0, 0x80, 0x41, 0x01, 0xC0, 0x80, 0x41, 0x00, 0xC1, 0x81, 0x40 };
```

### Low-Order Byte Table

```
/* Table of CRC values for low-order byte */
static char auchCRCLo[] = {
0x00, 0xC0, 0xC1, 0x01, 0xC3, 0x03, 0x02, 0xC2, 0xC6, 0x06, 0x07, 0xC7, 0x05, 0xC5, 0xC4, 0x04,
0xCC, 0x0C, 0x0D, 0xCD, 0x0F, 0xCF, 0xCE, 0x0E, 0x0A, 0xCA, 0xCB, 0x0B, 0xC9, 0x09, 0x08, 0xC8,
0xD8, 0x18, 0x19, 0xD9, 0x1B, 0xDB, 0xDA, 0x1A, 0x1E, 0xDE, 0xDF, 0x1F, 0xDD, 0x1D, 0x1C, 0xDC,
0x14, 0x04, 0x05, 0x15, 0x07, 0x17, 0x16, 0x06, 0xD2, 0x12, 0x13, 0x03, 0x11, 0x01, 0xD0, 0x10,
0xF0, 0x30, 0x31, 0xF1, 0x33, 0xF3, 0xF2, 0x32, 0x36, 0xF6, 0xF7, 0x37, 0xF5, 0x35, 0xF4, 0x34,
0x3C, 0xFC, 0xFD, 0x3D, 0xFF, 0x3F, 0x3E, 0xFE, 0xFA, 0x3A, 0x3B, 0xFB, 0x39, 0xF9, 0x39, 0xF8, 0x38,
0x28, 0xE8, 0xE9, 0x29, 0xEB, 0x2B, 0x2A, 0xEA, 0xEE, 0x2E, 0x2F, 0xEF, 0x2D, 0xED, 0xEC, 0x2C,
0xE4, 0x24, 0x25, 0xE5, 0x27, 0xE7, 0xE6, 0x26, 0x22, 0xE2, 0xE3, 0x23, 0xE1, 0x21, 0x20, 0xE0,
0xA0, 0x60, 0x61, 0xA1, 0x63, 0xA3, 0xA2, 0x62, 0x66, 0xA6, 0xA7, 0x67, 0xA5, 0x65, 0x64, 0xA4,
0x6C, 0xAC, 0xAD, 0x6D, 0xAF, 0x6F, 0x6E, 0xAE, 0xAA, 0x6A, 0x6B, 0xAB, 0x69, 0xA9, 0xA8, 0x68,
0x78, 0xB8, 0xB9, 0x79, 0xBB, 0x7B, 0x7A, 0xBA, 0xBE, 0x7E, 0x7F, 0xBF, 0x7D, 0xBD, 0xBC, 0x7C,
0xB4, 0x74, 0x75, 0xB5, 0x77, 0xB7, 0xB6, 0x76, 0x72, 0xB2, 0xB3, 0x73, 0xB1, 0x71, 0x70, 0xB0,
0x50, 0x90, 0x91, 0x51, 0x93, 0x53, 0x52, 0x92, 0x96, 0x56, 0x57, 0x97, 0x55, 0x95, 0x54, 0x94,
0x9C, 0x5C, 0x5D, 0x9D, 0x5F, 0x9F, 0x9E, 0x5E, 0x5A, 0x9A, 0x9B, 0x5B, 0x99, 0x59, 0x58, 0x98,
0x88, 0x48, 0x49, 0x89, 0x4B, 0x8B, 0x8A, 0x4A, 0x4E, 0x8E, 0x8F, 0x4F, 0x8D, 0x4D, 0x4C, 0x8C,
0x44, 0x84, 0x85, 0x45, 0x87, 0x47, 0x46, 0x86, 0x82, 0x42, 0x83, 0x41, 0x81, 0x40, 0x80, 0x40 };
```



## NOTE

Extra low voltages (ELV) or secure low voltages (SELV) are voltages up to 50 Volts.



## NOTE

Low voltages are voltages between 50 ... 250 Volts.

## INSTALLATION DIRECTION FOR SWITCHING LOWER VOLTAGES

For reasons of safety it is not allowed that extra low voltages and low voltages are connected to two adjacent relay contacts. Neither may different phases may be connected to two adjacent relay contacts. But a relay contact between them can be left empty.



If a Saia PCD® system module is connected to low voltage, then all components which are electrically connected to this system must be approved for low voltage.

When using low voltage, all connections to the relay contacts, which are connected to the same circuit, must be protected by a common fuse.

The individual load circuits, on the other hand, may be protected individually by a fuse.

### Wiring example with fuses and 3 phases

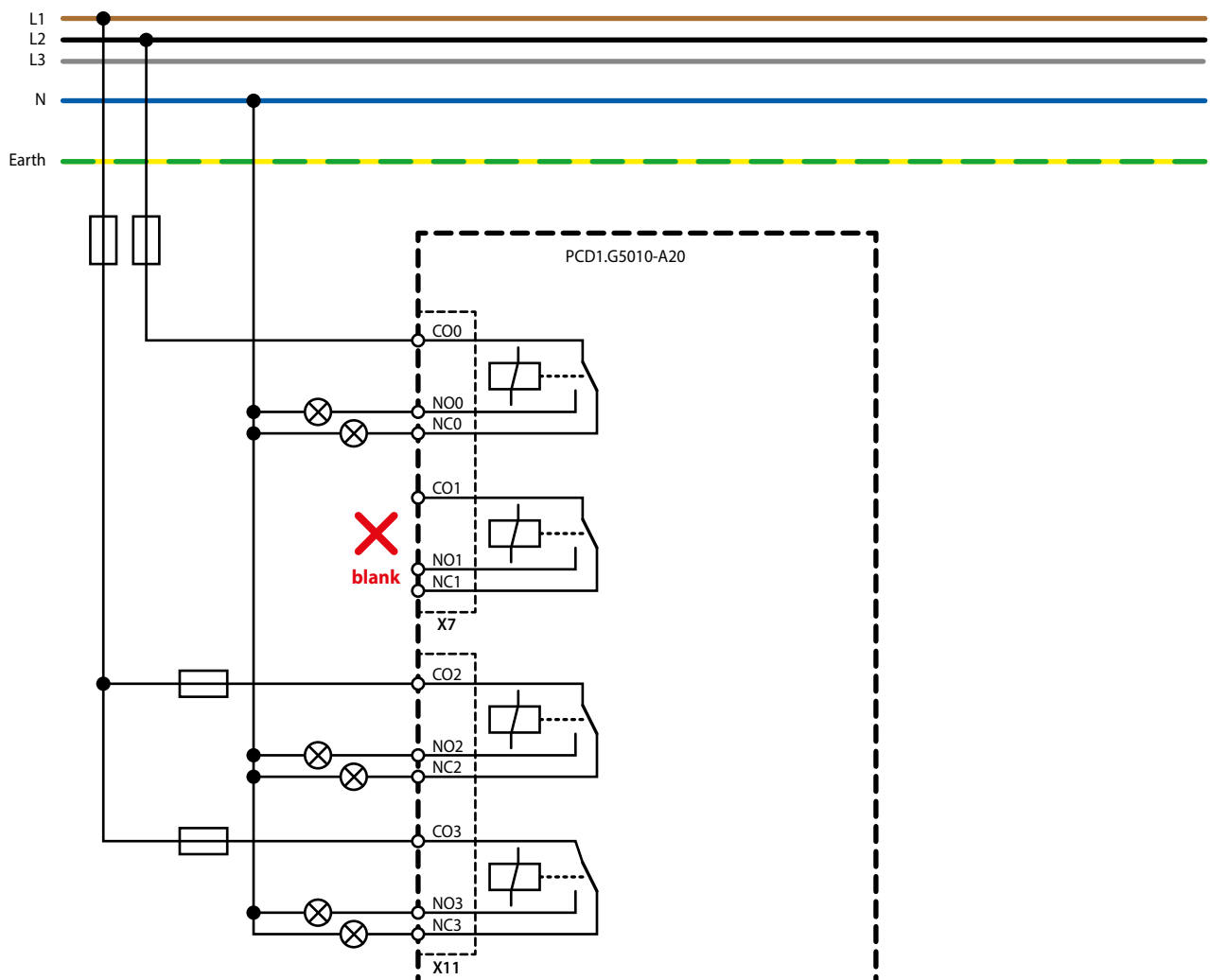



## ATTENTION

These devices must only be installed by a professional electrician, otherwise there is the risk of fire or the risk of an electric shock.



## WARNING

Product is not intended to be used in safety critical applications, using it in safety critical applications is unsafe.



## WARNING - Safety

The unit is not suitable for the explosion-proof areas and the areas of use excluded in EN 61010 Part 1.



## WARNING - Safety

Check compliance with nominal voltage before commissioning the device (see type label).  
Check that connection cables are free from damage and that, when wiring up the device, they are not connected to voltage.  
Do not use a damaged device!



## NOTE

In order to avoid moisture in the device due to condensate build-up, acclimatise the device at room temperature for about half an hour before connecting.



## CLEANING

The device can be cleaned in dead state with a dry cloth or cloth soaked in soap solution.  
Do not use caustic or solvent-containing substances for cleaning.



## MAINTENANCE

These devices are maintenance-free. If damaged during transportation or storage, no repairs should be undertaken by the user.



## GUARANTEE

Opening the module invalidates the guarantee.

Observe this instructions (data sheet) and keep them in a safe place.  
Pass on the instructions (data sheet) to any future user.



### WEEE Directive 2012/19/EC Waste Electrical and Electronic Equipment directive

The product should not be disposed of with other household waste. Check for the nearest authorized collection centers or authorized recyclers. The correct disposal of end-of-life equipment will help prevent potential negative consequences for the environment and human health.



EAC Mark of Conformity for Machinery Exports to Russia, Kazakhstan or Belarus.

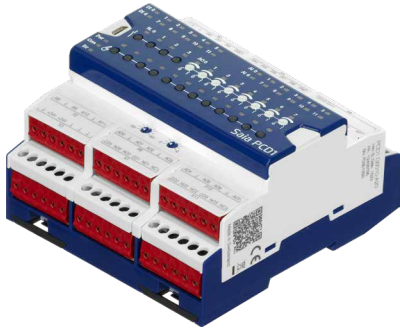

PCD1.G5010-A20

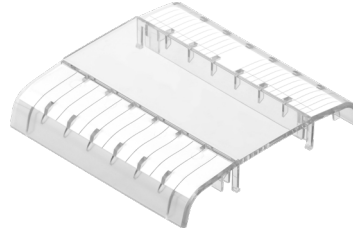

PCD1.K0206-005

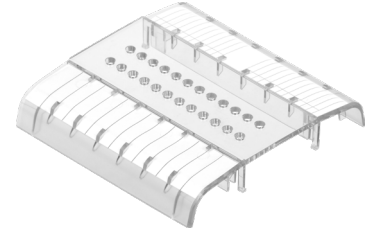

PCD1.K0206-025



Terminal set  
32304321-003-S

## Order details

Type	Short description	Description	Weight
PCD1.G5010-A20	E-Line RIO 12DI, 4Rel, 12AI, 8AO	E-Line combined input/output module Manual priority operating level for all outputs Status LED for inputs and outputs Supply 24 VDC 12 digital inputs; 24 VDC (source operation) 4 relay changeover 250 VAC / 30 VDC, 4 A (DC1) 12 analogue inputs; 12 bit, 0...10 V, -10...+10 V, Pt/Ni 1000, Ni1000 L&S, NTC, 0...2500 Ohm, 0...7500 Ohm, 0...300 kOhm 8 analogue outputs 10 bit, 0...10 V (10 mA max.) 1 interface RS-485 (S-Bus)	389 g
PCD1.K0206-005	E-Line labelling set 5 × 6 HP*	E-Line cover and labelling set consisting of 5 × covers (6 HP = 105 mm) and labelling sheet for mounting in the automation control cabinet	365 g
PCD1.K0206-025	E-Line labelling set 5 × 6 HP* with holes	E-Line cover and labelling set with holes consisting of 5 × covers (6 HP = 105 mm) with holes for manual override operating level and labelling sheet for mounting in the automation control cabinet	365 g
32304321-003-S	Terminal set	6-pin terminal. Set of 6 terminal blocks	40 g

\* Horizontal pitch: 1 HP corresponds to 17.5 mm

### Saia-Burgess Controls AG

Bahnhofstrasse 18 | 3280 Murten, Switzerland  
T +41 26 580 30 00 | F +41 26 580 34 99  
www.saia-pcd.com

support@saia-pcd.com | www.sbc-support.com