



Quick Start Guide REX 200/250 Router

Order numbers:

700-877-WAN02 | 700-878-WAN02

700-877-LTE02 | 700-878-LTE02

700-877-WIF02 | 700-878-WIF02

from firmware V 8.3.2

Version
9 en

Content

1	Safety instructions	5
2	Introduction to the function of the REX 200/250	6
3	Prepare and connection	6
3.1	Power supply	6
3.2	Power source requirement	7
3.3	Terminals and Interfaces	7
3.4	Installation position/minimum clearances	7
3.5	2x IO1 & IO2 digital inputs/outputs and 2x IN3 & IN4	7
3.6	REX 200/250 WAN	8
3.7	Antenna connection	8
3.7.1	REX 200/250 WiFi	8
3.7.2	REX 200/250 LTE (4G)	9
3.8	REX 200/250 LTE + REX 200/250 Wi-Fi with failover	9
3.9	Boot process	9
4	Access to the myREX24 V2 portal	10
4.1	Registration	10
4.2	Login to the myREX24 V2 portal server	11
4.3	Navigation in the portal	11
4.4	Simple and extended views	11
5	Initial router-configuration via the myREX24 V2 portal	12
5.1	Creating a new project	12
5.2	Creating a new device	13
5.3	Configure REX 200/250 (connection data)	13
5.4	Step 1 „Device “– Selection of the type and name	13
5.5	Step 2 „Internet“ – Network settings	14
5.6	Step 3 „Configuration “– Download file to PC	15
6	Router-configuration transfer options	15
6.1	Transferring the configuration using a USB flash drive	16
6.2	Synchronization	17
7	Connection to the machine network	18
8	Tips und tricks	19
8.1	Checking the device status	19
8.2	VPN port and China Gateway	21

8.3	Diagnostic page	22
8.4	Is a MAC address filter activated in the firewall? (relevant for internet access via P1 WAN interface) 22	
8.5	Is the connection established over a proxy? (relevant for internet access via P1 WAN interface) .	22
8.6	Device configuration: Services – NTP-Server	23
8.7	Device configuration: Services – Mail settings (relevant for internet access via P1 WAN interface) 23	
8.8	no or inadequate mobile communications connection	23
9	Remote maintenance of Ethernet CPUs	24
9.1	Device settings: Services – Firewall – SNAT	24
9.2	Search over IP	24
10	Setting up the MPI/PROFIBUS interface (REX 250 only)	25
10.1	Installing driver	25
10.2	Creating a station	25
10.3	Assigning an IP-Adresse and name	25
11	Setting up the VCOM LAN for serial communication (REX 250 only)	26
12	Description of LEDs and buttons	27
12.1	Function and status LEDs in normal operation	27
12.2	RJ45 network LEDs	27
12.3	Buttons	27
12.4	myREX24 V2 portal LEDs	28
13	Resetting to factory settings	28
14	Alternative configuration without myREX24 V2 portal	29
15	Load configuration from USB stick	29
16	Load firmware file from the USB stick	30
17	Technical data	31
17.1	REX 200/250 WAN	31
17.2	Additional interfaces REX 250	32
17.3	REX 200/250 LTE	32
17.4	REX 200/250 WiFi	33

Important preliminary information on the new security functions from portal version 2.16.3

The myREX24 portal informs you with a message box about the status that the REX first requires an initial configuration. The process described there is only required once per device.

If you create a new REX device in the portal, you can set all the device parameters required for your project as usual. However, only the basic configuration parameters are transferred to the device during the initial transfer to the router.

These values, which are included in this initial configuration, are highlighted in color for your information:

LAN

Internet

WAN

Modem

If the firmware version has been adjusted in the system settings of the REX device, the myrex24.initial file can be downloaded from the portal using the corresponding button directly via a LAN connection (transfer configuration to device) or via USB (download configuration to PC). In the USB variant, a "myREX24.initial" file is generated. This must not be renamed and can then be transferred to the device as described in this QSG instruction.

Attention! Please ensure that the required firmware is active in the respective REX device so that the following step can be carried out successfully.



ATTENTION

At least version 8.3.2 or higher in all REX 200/250 products

Once the initial configuration has been transferred, the router will automatically establish contact with the portal in order to retrieve its complete configuration. Please do not interrupt the power supply or carry out a RESET on the device during this time!

Please note that the router must connect to the portal twice for the process described above before the REX is ready for use in your application

1 Safety instructions

Target audience



This description is only intended for trained personnel qualified in control and automation engineering who are familiar with the applicable national standards. For installation, commissioning, and operation of the components, compliance with the instructions and explanations in this operating manual is essential. The specialist personnel is to ensure that the application or the use of the products described fulfills all safety requirements, including all applicable laws, regulations, provisions, and standards.

Intended use



The device has a protection rating of IP 20 (open type) and must be installed in an electrical operating room or a control box/cabinet in order to protect it against environmental influences. To prevent unauthorized operation, the doors of control boxes/cabinets must be closed and possibly locked during operation. The consequences of improper use may include personal injury to the user or third parties, as well as property damage to the control system, the product, or the environment. Use the device only as intended!

Operation



Successful and safe operation of the device requires proper transport, storage, setup, assembly, installation, commissioning, operation, and maintenance. Operate the device only in flawless condition. The permissible operating conditions and performance limits (technical data) must be adhered to. Retrofits, changes, or modifications to the device are strictly forbidden. The devices contain components that can be damaged or destroyed by electrostatic discharge. When handling the devices, observe the necessary safety measures against electrostatic discharge (ESD) in accordance with EN 61340-5-1 and EN 61340-5-2.

Security



The device is a network infrastructure component and therefore an important element in the security consideration of a plant. When using the device, therefore, observe the relevant recommendations to prevent unauthorized access to installations and systems.

RF radiation



Device variants with an integrated modem should be installed and operated with a minimum distance of 20 cm between the radiator / antenna and your body.

Information

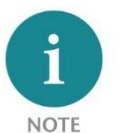

This document explains the initial commissioning of the REX 200/250 Router. The latest version of the document and a detailed manual can be found at www.helmholz.de or scan the QR code directly.



2 Introduction to the function of the REX 200/250

The REX 200/250 is an industrial router suitable for worldwide remote access (depending on the REX variant) to IPv4-capable end devices (PLC, HMI, IP cameras, etc.). This Quick Start Guide explains the basic settings in the myREX24 V2 portal and shows how to transfer the configuration made there to the REX 200/250 unit.

No integration into a PLC engineering tool by means of a GSDML file is necessary and system states can be viewed and diagnoses can be carried out on the password-protected website of the device.

Internet access and a valid account for the myREX24 portal are required for the configuration. The free of charge software shDIALUP for Windows operating systems is available to you by downloading from www.helmholz.de.



NOTE

We recommend using the current version (from V3.7R1.0) of the "shDIALUP" client software for commissioning. For a successful and secure connection to the myREX24 V2 portal, the firmware status of all REX routers should be checked regularly and, if necessary, updated with the help of the system settings in your myREX24 account.

3 Prepare and connection

Depending on the REX variant, the LAN ports P1 to P4 or P2 to P4 are available for connection to the machine network. Internal switch functions are active even if the REX 200/250 router is not connected to the Internet.

For devices with a modem, antennas available as accessories and a mini-SIM card (except for Wi-Fi variants) are required for access to a GSM network.

This serves the purpose of identification for the network operator. The insert is found on the left housing side. In order to unlock and remove the insert, please press the recessed yellow button next to the card reader. Please use the supplied tool (SIM card ejector) for this.



NOTE

When selecting a mobile phone contract, please use a standard mobile phone data tariff. Please avoid IoT tariffs, because these are often only designed for small amounts of data or low transmission speeds.

3.1 Power supply

The REX 200/250 is designed exclusively for operation with safety extra-low voltage (SELV / PELV) and is supplied with 24 V DC via the supplied connector.



NOTE

The housing of the REX 100 is not earthed. Please make sure to connect the functional earthing connection (FE) of the device to the reference potential of your control cabinet or system structure in order to ensure correct ESD derivation of the antenna and network sockets.

The device is intended to be supplied by an isolated Limited Energy Source according to UL61010-1 (3rd ed cl. 9.4) or according to UL60950-1/UL62368-1 or Class 2 according to NEC. Please use Cu power supply wires, AWG 28-12. Maximum length of removed insulation is 10 mm. Temperature cable rating is 87 °C.

3.2 Power source requirement

This device may only be operated with power supplies that meet the requirements of EN 62368-1 for power sources of limited power. Otherwise, the device must be operated in a housing that meets the requirements of fire protection according to EN 62368-1.

3.3 Terminals and Interfaces

Rigid copper wires with a max. diameter of 1.5 mm² can be clamped onto the provided connector plug. Network cables corresponding to at least category 5/5e (CAT-5) should be connected to the RJ-45 sockets.

3.4 Installation position/minimum clearances

The router was designed to be mounted on DIN rails (as per DIN EN 50 022) and intended for installation in switch cabinets. Installation and mounting must take place in accordance with VDE 0100/IEC 364. The router can be installed in any position.

It is recommended that minimum clearances to neighboring assemblies are observed during assembly. If the distances 30 mm on the top and on bottom and 10 mm on each side are maintained, easy access to the connections and contact options on the router is possible without having to remove other system parts. In addition, there should always be enough space for the necessary cable routing.

3.5 2x IO1 & IO2 digital inputs/outputs and 2x IN3 & IN4

Due to the electrical isolation of the bi-directional input/output wiring, an additional supply voltage of 24 volts DC must be applied. The alarm inputs can be activated with potential-free switches, buttons or relay contacts.

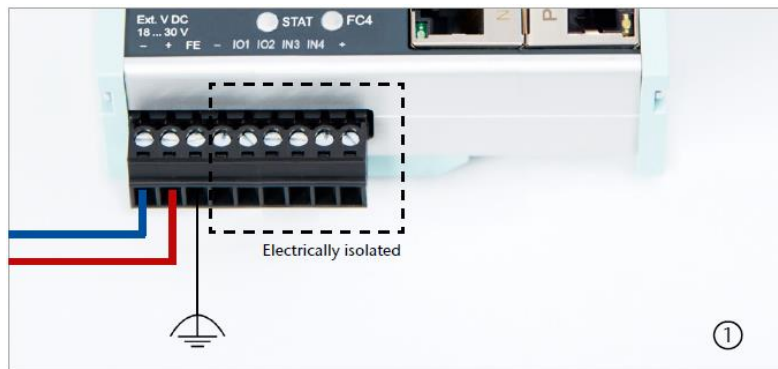

Depending on the configuration in the myREX24 V2 portal, one to four (or, in the case of multiplex wiring, up to 99) different email/text message recipients can be alerted with individual message texts. One input each can also be configured for establishing the connection to the myREX24 V2 portal or for a REX system restart.

The configurable output wiring makes available signals for the status of an active Internet, VPN or user connection or a device fault of the REX 200/250.

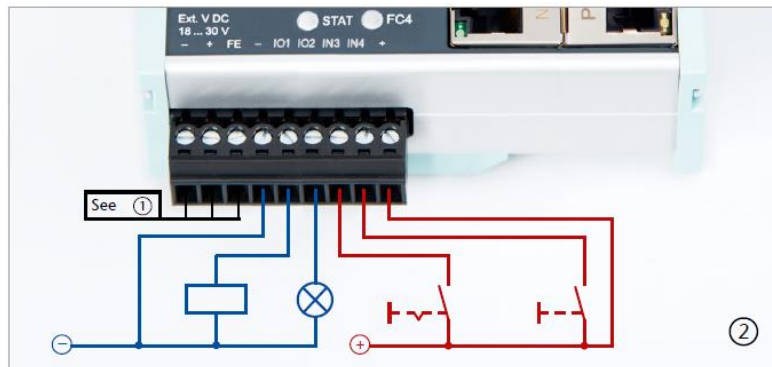

When using outputs O1 and O2, the corresponding input signals I1 and I2 assume the respective output status and can themselves no longer be used externally for other alarm input signals.

3.6 REX 200/250 WAN

Connect the WAN interface of the REX 200/250 (P1 WAN) with a patch cable with the higher level (company) network/router. All device variants have 4 additional LAN ports for connection to the machine network and for commissioning via PC.

3.7 Antenna connection

Only connect antennas that are included in the Helmholtz accessories and ensure prior to installation that the antenna is positioned in such a way that the modems receive a permanent radio signal to a WLAN access point or can connect to an adequate 4G mobile network. Also be sure to follow the instructions from the technical data sheets of the antenna manufacturer and do not install these into metal housings (e.g., control cabinet).

3.7.1 REX 200/250 WiFi

With this device variant, a wireless connection to the Internet can also be configured as an alternative to the P1 WAN interface. The WLAN radio module only works in the 2.4 GHz range and it must be ensured that the required inter-net connection can be established via an existing access point in the (company) network. The required WLAN antenna is connected to the RP-SMA socket.

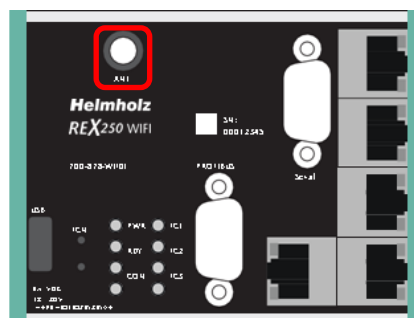

3.7.2 REX 200/250 LTE (4G)

For radio reception, a suitable antenna must at least be screwed onto the SMA socket “MAIN”. In order to improve the data throughput, a second antenna terminal is available on the REX 100 LTE router with the SMA socket “Rx” that can be used as an option. This functionality is called antenna diversity in the “WCDMA mode” and Downlink-MIMO in the “LTE mode”. The second receiver antenna should not be located in the immediate vicinity of the main antenna. In order to improve the diversity gain and reduce other reciprocal interactions (interference effects), the two antennas should be (taking the space available in the application into account) installed with the greatest possible distance between them.

For the same reason, the second antenna should be mounted cross-polarized (rotated by 90° in relation to the main antenna).

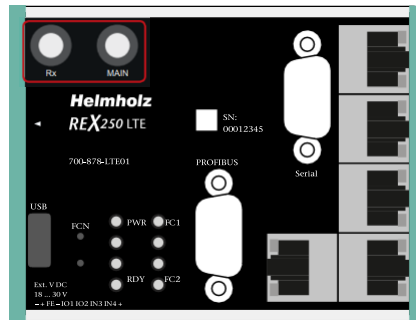

3.8 REX 200/250 LTE + REX 200/250 Wi-Fi with failover

Only with this device variant, a failover can be parameterized in the configuration if required (see chapter 5.5). For this application, connect the WAN interface (P1 WAN) of the REX 200/250 with a patch cable to the higher-level (company) network/router.

Furthermore, the requirements from points 3 and 3.6 must be met. The VPN connection is primarily implemented via the WAN interface. If the connection is not established or is interrupted, the REX 100 automatically switches to the appropriate wireless connection. As soon as WAN is available again, it switches back. The switchover takes place with a delay to detect if there is just a short interruption.

Application example

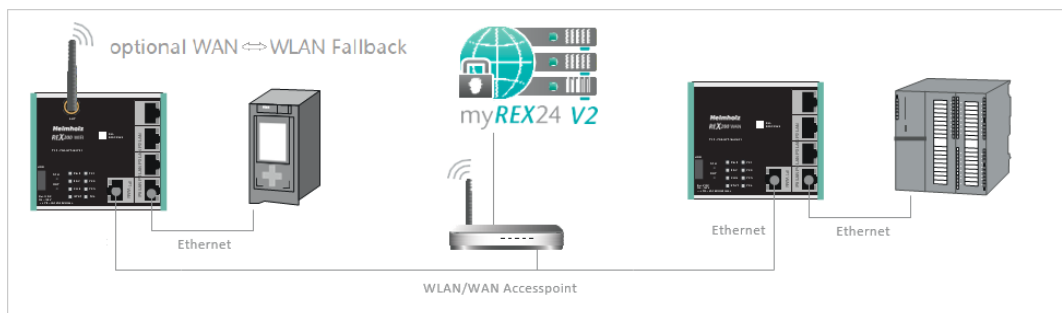

3.9 Boot process

The PWR LED lights up when the 24-volt supply voltage is applied. The boot process starts following the internal system check, which is indicated by the blinking RDY LED. The REX 100 is ready for operation as soon as the PWR LED and RDY LED light up continuously (duration: approx. 90 sec.).



ATTENTION

The 4G products 700-877-LTE01 and 700-878-LTE01 are intended for use in Europe and Asia. Before using an LTE router, please compare the LTE frequency bands of the selected device with the supported frequency bands of the provider in the country of use.

If you have any further questions on this issue, our technical sales team will be happy to help you.

4 Access to the myREX24 V2 portal

The complete configuration of the REX 200/250 can be done via the myREX24 V2 portal.

The shDIALUP remote client software enables you to administrate the myREX24 V2 portal and realize a VPN tunnel to a REX router. The software (shDIALUP) can be found in the download area at www.helmholz.de. There you can also download more documents with additional information at any time.

Alternatively, you can create the REX configuration on the myREX24 server with an HTTPS-secured direct call from your browser. The call is possible via the following URL: <https://v2.myREX24.net>. However, it is not possible to realize a VPN remote maintenance via the browser.

Always use your myREX24 V2 account data to log in.



NOTE

Information on alternative parameterization methods can be found in Chapter 14.

4.1 Registration

You should only register at www.myREX24.net if you do not yet have a myREX24 V2 portal account or have not received user access from a myREX24 account administrator.

Request Access to myREX24 V2

You can request an access for the myREX24 V2 portal here.

Please download the [General Terms and Conditions of myREX24 V2](#) here.

Company*

Salutation

Mr

First name*

Last name*

Street, No*

Fill out the required fields there. After your data is checked by our service team (Mon. to Fri., 8 a.m. to 5 p.m. CET), you will receive two separate e-mails with the access data.

One e-mail contains the username, and the second the password.

4.2 Login to the myREX24 V2 portal server

Install the shDIALUP software with administrative rights under a Windows operating system. After opening the program, select the “V2.myREX24.net” server in the top menu bar and then log in to the myREX24 V2 portal with your access data.

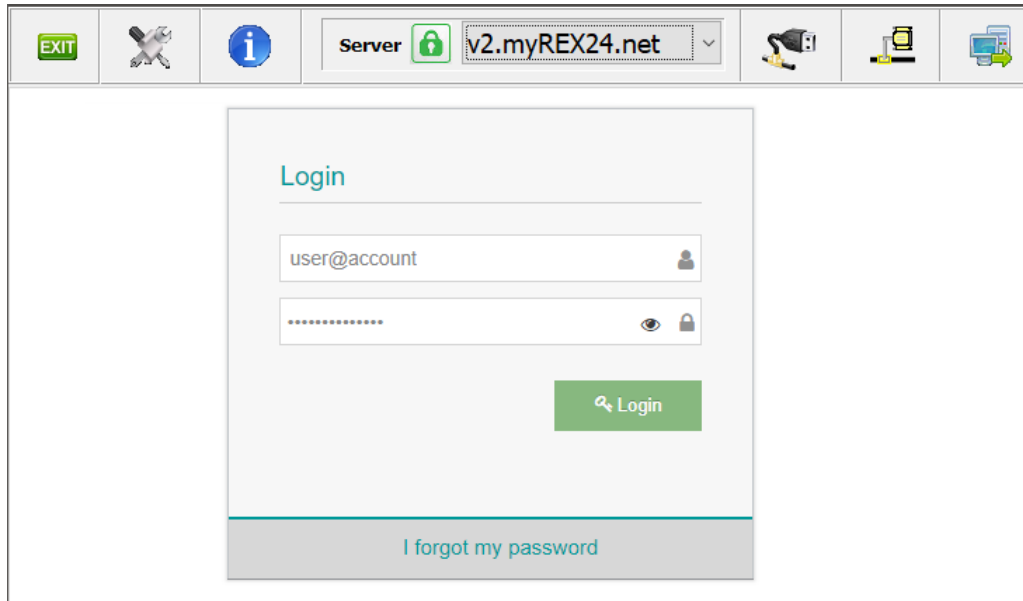

NOTE

Your login name can be comprised of your username and company name separated by the @ symbol, for example: admin@helmholz

Following the initial login, you will be prompted to register a new, individual password for your account. As the account administrator, you can create and administer additional users after logging in to the myREX24 V2 portal if necessary.

4.3 Navigation in the portal

Once a user has logged in for the first time, he or she is guided through a tutorial. Navigation, basic settings and switching from the simple view to the extended view are shown.



4.4 Simple and extended views

You can choose between the two views in the menu interface of the myREX24 V2 portal. The “simple view” is active the first time you log in. You can switch to the “extended view” at any time without changes being lost or losing their validity.



The simple view is mainly used throughout the rest of this Quick Start Guide. The extended view is also presented in some places for purposes of illustration.

5 Initial router-configuration via the myREX24 V2 portal

The following information describes the basic configuration steps required to set up a REX router for a VPN connection. A description of the extended functions can be found in the online help or in the manuals/white papers.

You can go to the online help in the myREX24 V2 portal using the question mark symbol in the lower left-hand area of the screen.

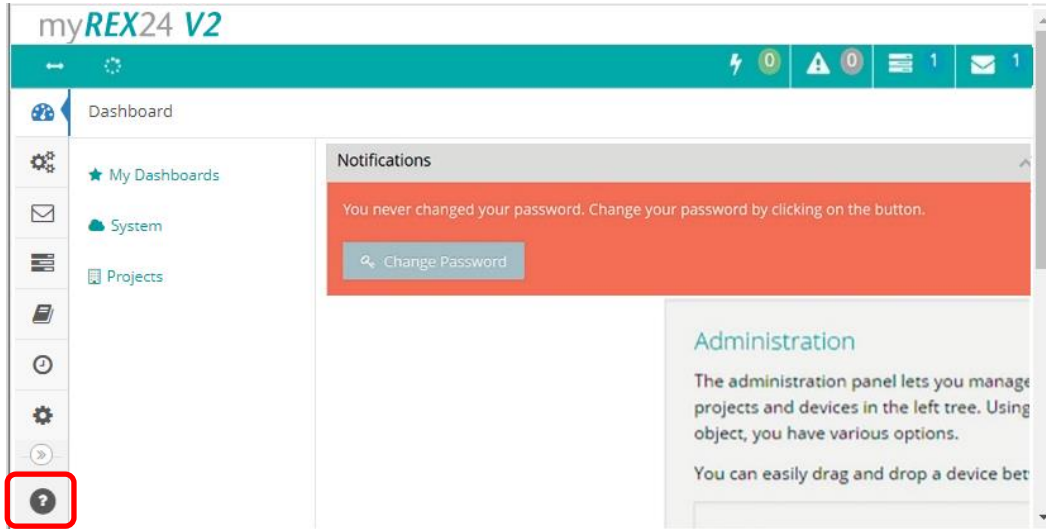

When you log in for the first time, the myREX24 portal guides you through a brief tutorial. It is recommended to re-issue the password for your myREX24 account once in accordance with the tutorial.

5.1 Creating a new project

A project is the highest level for carrying out the following tasks:

- - Device administration
- - Remote maintenance
- - Monitoring and alarms
- - Data logging
- - Visualizations

Initially, at least one new project must be created in which a router is assigned. Navigate to the Administration section by using the marked symbol (the tutorial also brings you to this point).

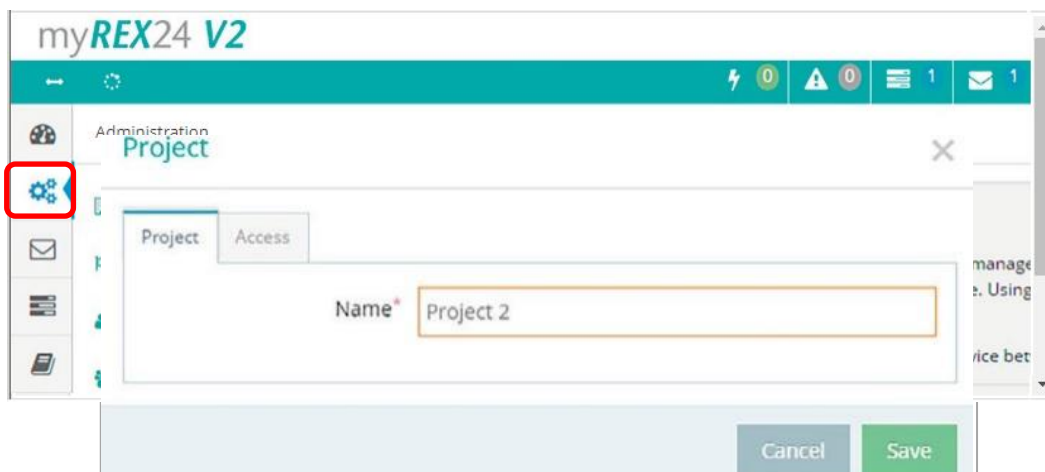

A unique “project” name is now issued in this menu. Additional account users, if created, can be assigned to this project on the “Access” tab.

5.2 Creating a new device

A router can be added to the tree structure using the green plus symbol or with a right-click of the mouse.

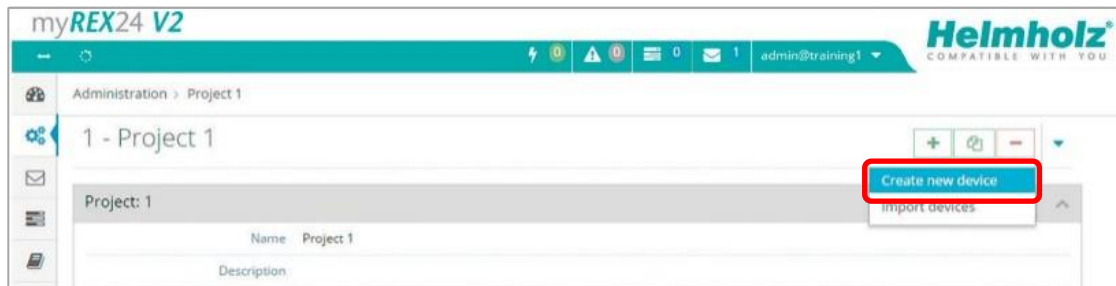

If a project does not yet have a router, the same function is made available in the main view by way of the green button “Create new device”.

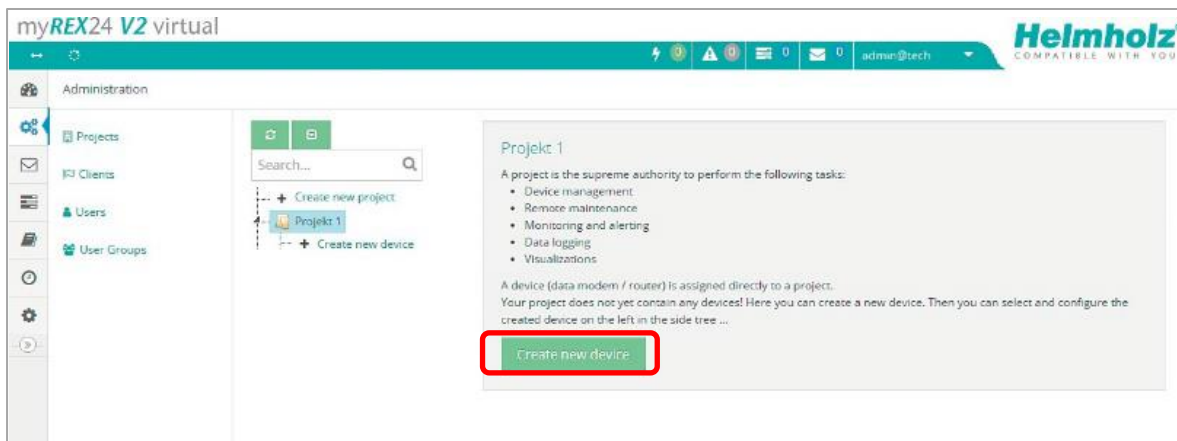

Clicking the respective button starts the configuration assistant, which guides the user through the settings.

5.3 Configure REX 200/250 (connection data)

Three simple steps are enough for minimal configuration of the router.

- Selection of the device type
- Network settings
- Transfer of the configuration to the REX router

5.4 Step 1 „Device “– Selection of the type and name

In the first step, the correct device type (matching the device order number) must be selected. A unique, freely selectable name should be assigned to this router.

Only numbers and letters may be used (0 to 9, A to Z, a to z and no spaces or special characters).

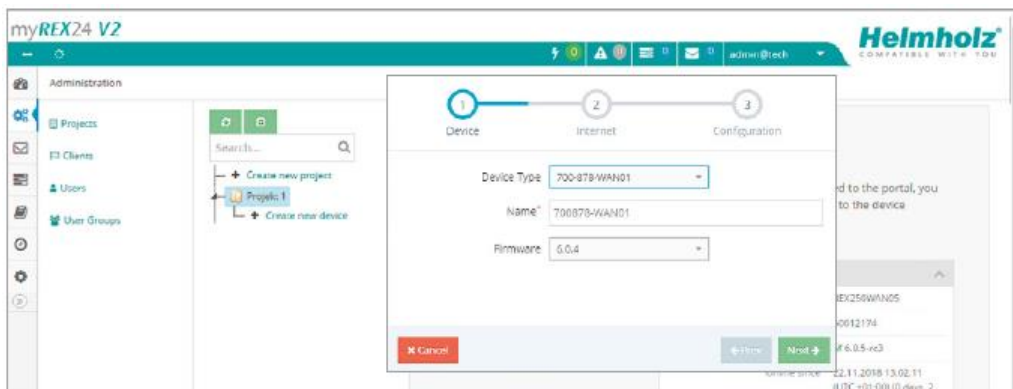

5.5 Step 2 „Internet“ – Network settings

In Step 2, the network configuration for the LAN, WAN and, depending on the version, the LTE cellular or the Wi-Fi settings must be defined.

- LAN All REX 200/250 routers come with the IP address 192.168.0.100/24 as a default. If necessary, modify the IP address and subnet mask according to the specifications from the machine network to be maintained remotely.
- WAN The required information for the DHCP or static IP settings is provided by the respective network administrator. DHCP is preset at the factory.
- Modem The parameters for the APN access point (Access Point Name) of the card provider and the correct SIM PIN must be available to you and be stored here. There are already several providers available for selection (sorted by country). If the correct provider is not present, this can also be entered manually.
- WLAN Enter the Wi-Fi-specific access data. The corresponding data provides you with the responsible network administrator.



If you use DHCP, make sure that the DHCP server does not assign an IP address the WAN interface that is already active on the LAN side. IP addresses from two different subnets must be assigned to each router's LAN and WAN interfaces.

Examples: LAN network settings, WLAN or APN access data and download

The image displays two screenshots of a configuration interface. The top screenshot shows the 'Internet' step (step 2) with LAN settings (IP: 192.168.0.100, Netmask: 255.255.255.0) and WiFi Access settings (SSID, Authentication Mode: SHARED, Encryption Mode: None, Encryption Key, Channel: Auto, WiFi Type: DHCP). The bottom screenshot shows the 'Configuration' step (step 3) with LAN settings (IP: 192.168.0.100, Netmask: 255.255.255.0) and Modem settings (Mobile APN (Provider): enter login information, APN, User). A 'Download' button is highlighted in red in the bottom screenshot.

5.6 Step 3 „Configuration “– Download file to PC

In step 3, the basic settings of a minimum configuration for the REX 100 are now stored in your portal account and must now be transferred to the device. By clicking on the download button (here marked in red), the configuration file is downloaded from the portal server and can then be transferred to the REX router using a FAT-formatted USB stick.



NOTE

We recommend the “Download configuration to PC” variant for the initial configuration.

6 Router-configuration transfer options

Newly created or subsequently modified device configurations can be transferred to the REX 200/250 in a variety of ways.

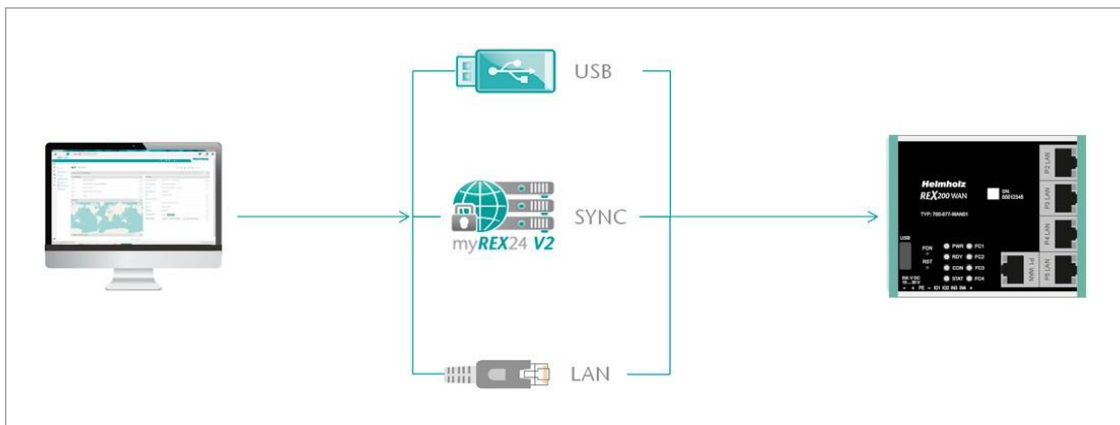

1. Download configuration to PC (via USB flash drive). The configuration file is saved on the PC and can subsequently be transferred to the REX 200/250 using a USB stick (subsequent procedure described in chapter 6.1).
2. Synchronize (recommended for subsequent modifications). If the router has already been configured and a connection with the portal is established, each subsequent change to the configuration can be carried out via the existing VPN remote connection (further procedure described in Section 6.2).
3. Transfer configuration to the device (with LAN connection, only possible via shDIALUP). For this configuration option, the REX 200/250 must be accessible directly in the LAN from the PC. The PC must also be logged in on the Internet via the shDIALUP dial-up client using your myREX24 account at the same time.

The transfer via USB stick (point 1) is explained in this Quick Start Guide, and how retroactive changes can be transferred via the function “Synchronization” (Point 2).

6.1 Transferring the configuration using a USB flash drive

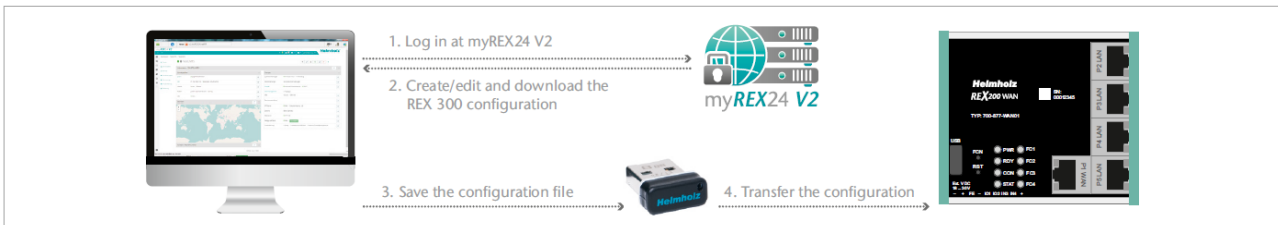

Ensure that the power supply is connected to the REX 200/250. Download the configuration file provided through the myREX24 portal to the FAT-formatted USB flash drive connected to your PC using the download symbol.



The myrex24.initial configuration file must be stored in the root directory of your USB flash drive and may not be renamed.

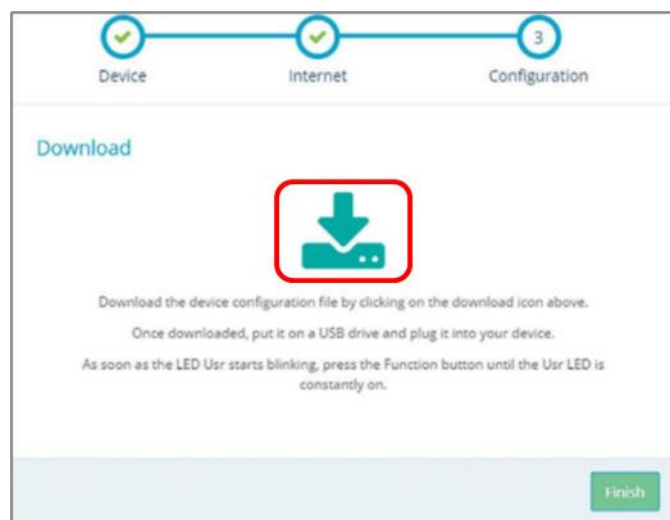

Now carry out the steps described in chapter 15 “Load configuration/ firmware update from the USB stick”.

6.2 Synchronization

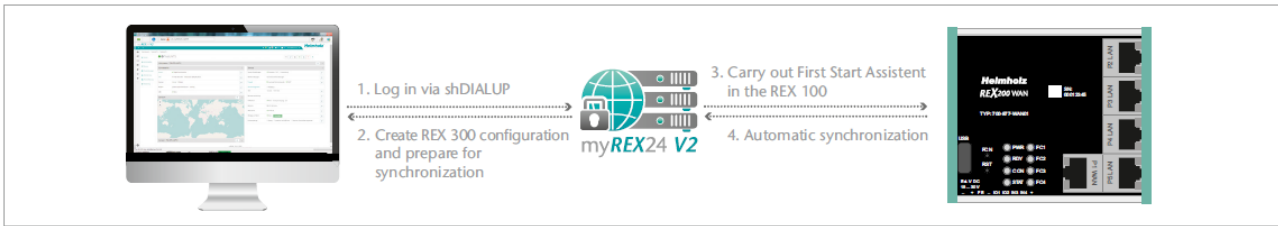

As soon as the REX 200/250 has logged into your account in the portal, you can transfer subsequent changes at any time with “Synchronize”. Where there is an existing myREX24-V2 portal connection, the REX 200/250 checks cyclically whether there is a new configuration available for its serial number and then loads it automatically.

As soon as you have modified and saved one or more parameters, a gray exclamation mark symbol appears next to the in green animated online LED with the tooltip: "Device configuration not up to date". Click this symbol (or the "Synchronize" button) to start the process.

Synchronization in the *simplified view*:

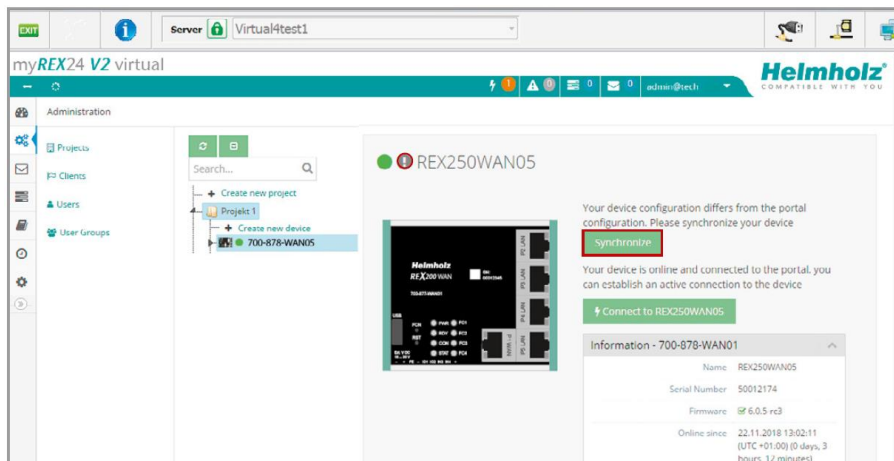

Synchronization in the *extended view*:

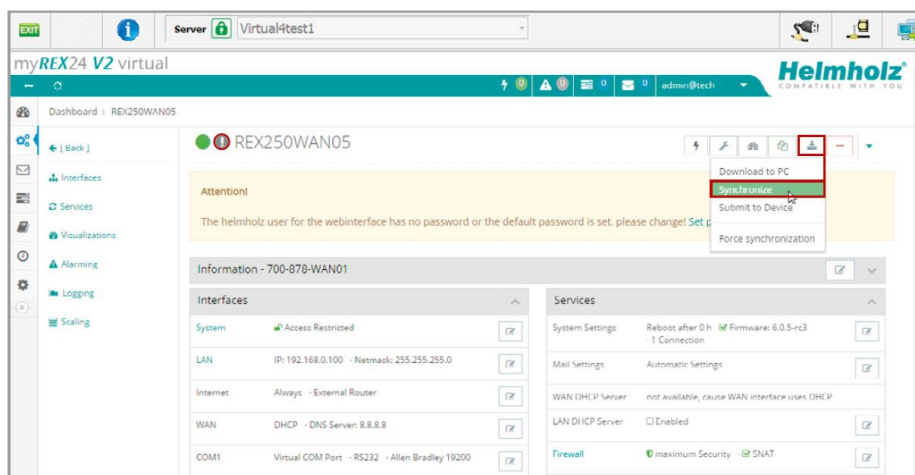

The synchronization function is confirmed through the following dialog:

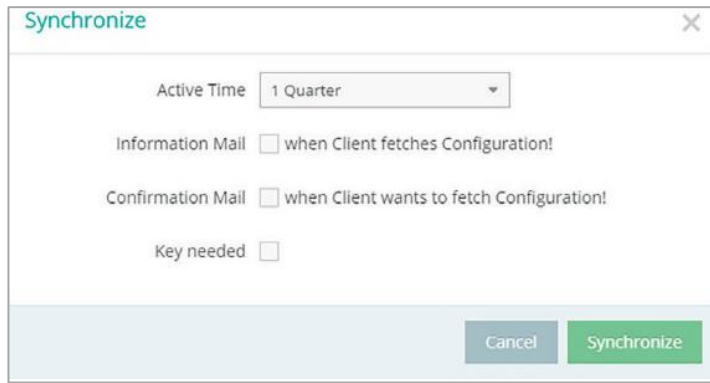

In this menu, you can select optional user-defined settings, such as the sending of information/confirmation mails.

The REX router now accepts the new settings and restarts automatically. As soon as the boot process has concluded, the REX router logs into the portal again.

7 Connection to the machine network



NOTE

The following steps presume that the REX 200/250 has already been configured and that you have successfully logged into your account with shDIALUP. A secure VPN connection to the end device cannot be implemented via the browser view (<https://v2.myREX24.net>).

Logged-in REX 200/250 routers are identified with a green circle in the dashboard. The secure VPN connection between the PC and REX router is not established until the connection button is clicked.

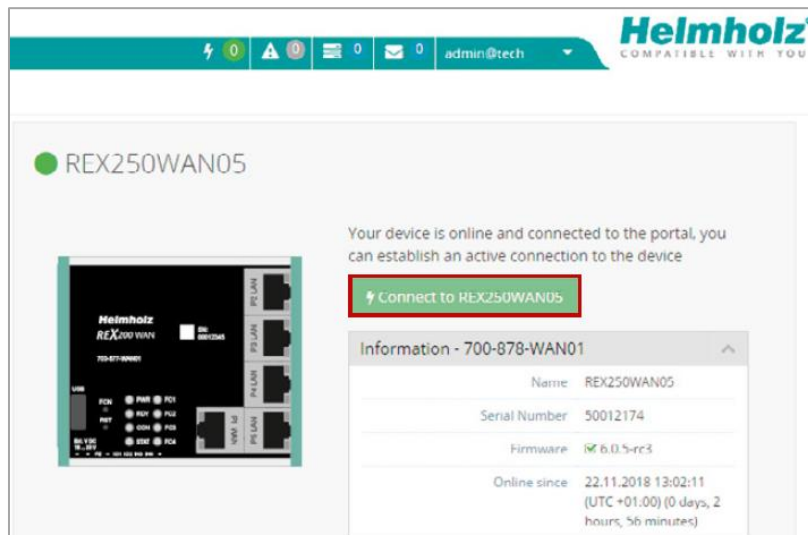

Effective immediately, you can view the setup of your REX router and the functional overview of the myREX24 V2 portal very easily online.

<https://youtu.be/r4KxIV-VgdY>

Video tutorial (3:22 min.)



The active connection status to the REX 200/250 is represented by an animated orange connection button. The number of active connections made using this account is shown with details in the menu bar.

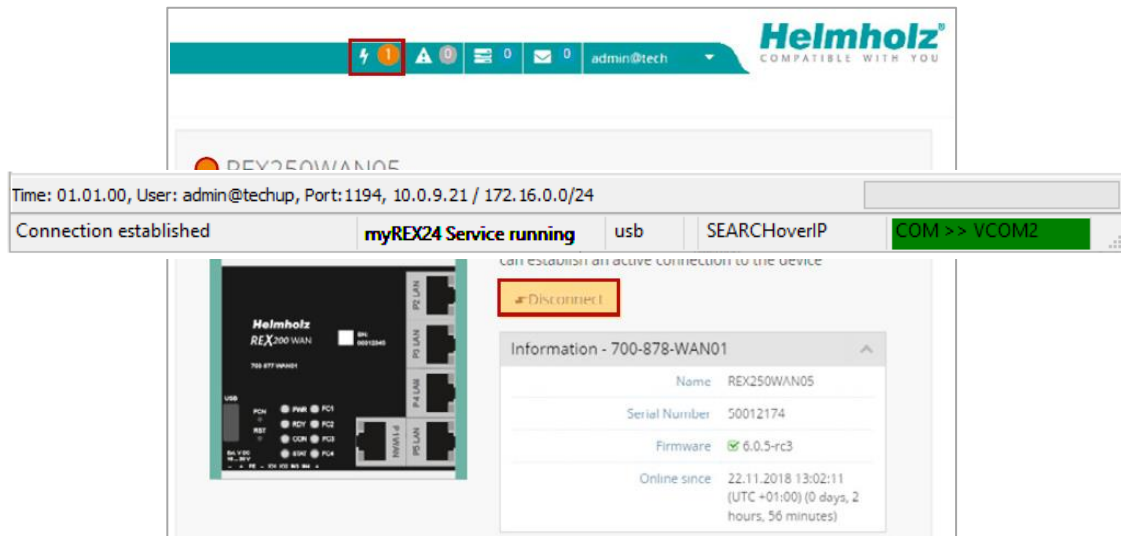

Once the VPN connection to the REX 200/250 has been established, all the IPv4 packets valid for the applicable LAN network on the system side will be forwarded. The parameters (port, VPN IP, LAN IP etc.) used for this connection are also shown with details in the status bar at the bottom.

To end a remote access connection, click the orange animated connection button and then confirm disconnection of the remote connection.

8 Tips und tricks

8.1 Checking the device status

The device status website of the REX 200/250 shows the connection status and the active configuration data of the router. To this purpose, the REX 200/250 must be accessible in the LAN, meaning that the TCP/IP address of a PC must be in the same IP subnet. To this purpose, enter the LAN IP address of the REX 100 into the address bar of a browser. The authentication information is printed on the back of the device.



Example of a preset individual device password:



NOTE

The access data for the web interface can be changed in the myREX24 portal in the respective device settings under "Services - User Administration" or additional users can be created for this REX router.

Please note that access to the web interface is only possible via the HTTPS protocol (<https://192.168.0.100>).

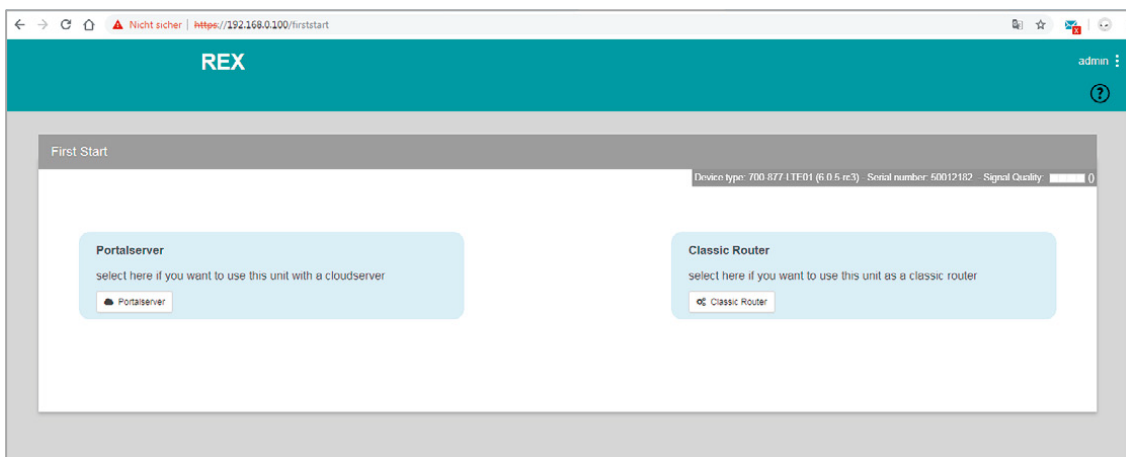

The First Start Assistant then opens. You must select “Portalserver” for the myREX24 portal configuration described here.

Using the extended view for the “Classic Router” is preferable for the configuration of your own VPN connections using the device web interface. There you can find extended setting options for the configuration of VPN connections that are independent of myREX24 portal.

To get more information on each step of the router connection, click the Info icon in the various status fields.

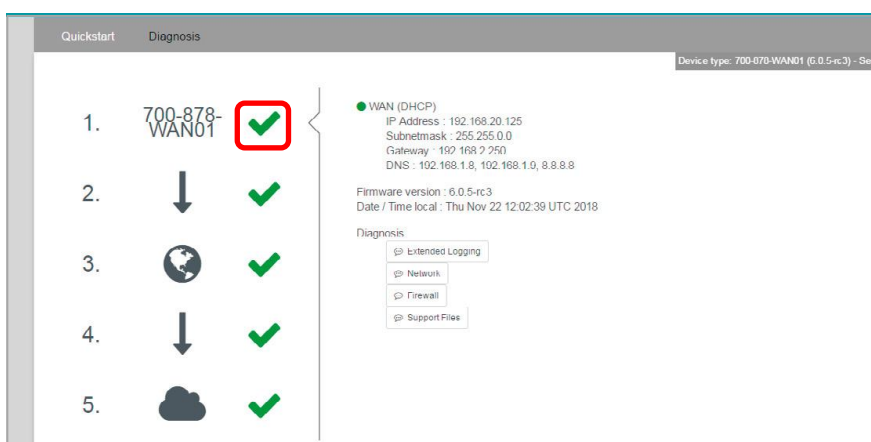

NOTE

The web interface at the routers can be deactivated for security reasons. If the interface is not accessible, please check the corresponding setting in the myREX24 portal. Make sure that there are no address space conflicts with any other network interfaces (do not assign the same IP address more than once) on your PC so that you can communicate properly with the REX 200/250.

8.2 VPN port and China Gateway

The REX 200/ 250 establishes an outgoing VPN connection via port 1194 (TCP) to the address vpn-v2.myrex24.net (5.39.123.21) by default.

As an alternative you can also configure port 80 or 443 (device configuration menu “Services” -> “VPN” -> “VPN Port”).

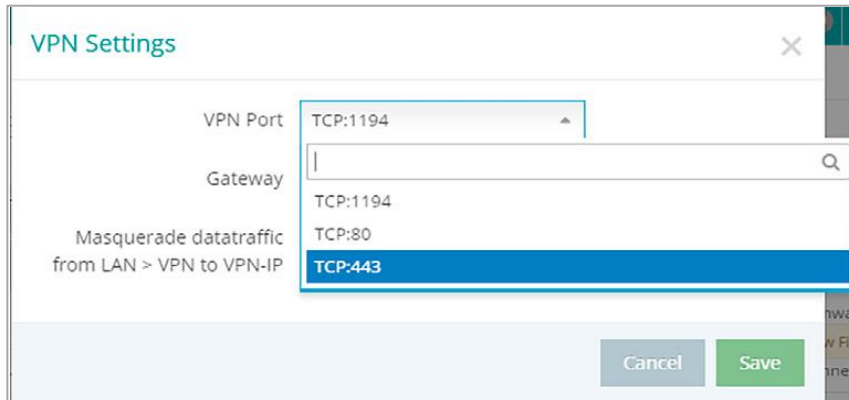

Relevant for Internet access via the WAN interface: clarify all details about the settings in advance with the responsible IT department. In order to be able to establish a secure connection to the myREX24 V2 server with shDIALUP or the REX router, at least one of the following TCP ports (80, 1194 or 443) must be open for the VPN tunnel in the customer's firewall.

China Gateway: By default, *No Gateway* is set

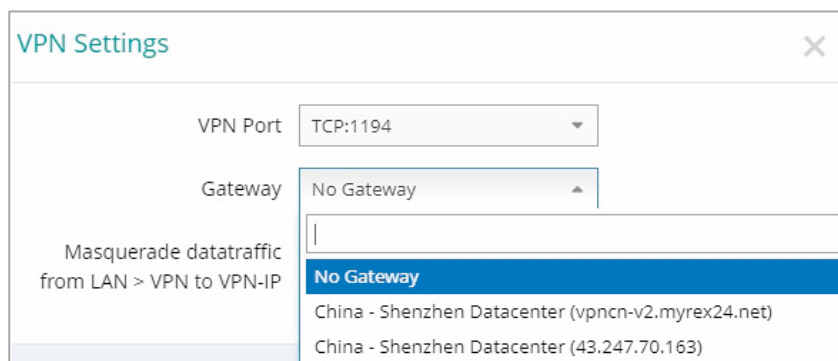

If the REX Router is used in China, the Gateway “China –Shenzhen Datacenter” can be selected.

URL: vpncn-v2.myrex24.net

IPv4 address: 43.247.70.163 (if name resolution does not work).



Do not use the China Gateway outside China!

8.3 Diagnostic page

In the event of irregularities or interruptions when establishing the connection, the diagnostics page supports you with troubleshooting. In the event of an error, the technical support of Helmholtz requires the respective result from the individual and autonomous test functions.

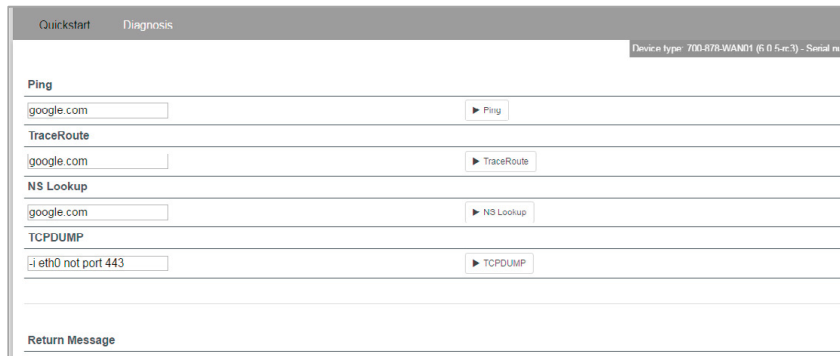

8.4 Is a MAC address filter activated in the firewall? (relevant for internet access via P1 WAN interface)

It may be necessary to approve the MAC address of the REX 200/250 in the higher-level DSL modem or firewall. Should it not be possible to establish a connection, please ask the respective network administrator whether such a MAC address filter has been activated.

8.5 Is the connection established over a proxy? (relevant for internet access via P1 WAN interface)

If a connection is not established on the customer network, the required proxy settings may not have been stored or may be faulty. These settings may be adjusted on the configuration page of the REX 200/250 in the Internet settings.

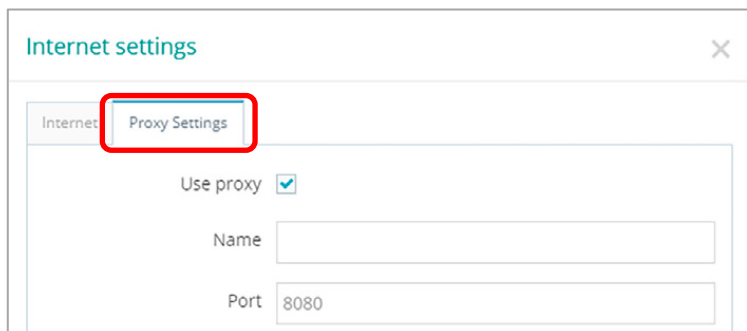

8.6 Device configuration: Services – NTP-Server

For the internal system time of the REX 200/250, this carries out a comparison using a time server on the Internet at regular intervals. Where necessary, you can individually set the preset NTP server entry and the interval.

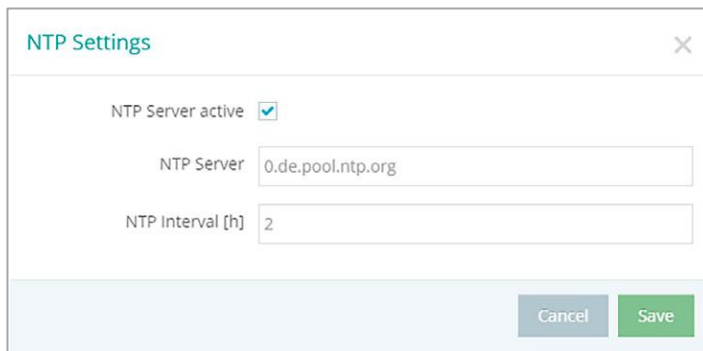

The screenshot shows a dialog box titled "NTP Settings". It contains the following elements:

- A checkbox labeled "NTP Server active" which is checked.
- A text input field labeled "NTP Server" containing the value "0.de.pool.ntp.org".
- A text input field labeled "NTP Interval [h]" containing the value "2".
- At the bottom right, there are two buttons: "Cancel" and "Save".



NOTE

Various functions in the myREX24 portal require a current time setting in the REX 200/250.

8.7 Device configuration: Services – Mail settings (relevant for internet access via P1 WAN interface)

If you would like to use the REX 200/250 function for the automatic sending of e-mails, port 25 (SMTP) may not be blocked in the firewall of the customer network. You can also use alternative e-mail servers to send e-mails.

8.8 no or inadequate mobile communications connection

In the event that the connection of your REX 200/250 router with the portal is not established for mobile communications remote maintenance or is interrupted during operation, the following parameters, among others, should be checked:

- incorrect SIM PIN stored in the REX router.
- no credit on prepaid SIM cards.
- blocked ports (dependent upon provider).
- impaired GSM reception quality due to unfavorable antenna location.
- selection of an antenna with inadequate transmission/receiving performance.

9 Remote maintenance of Ethernet CPUs



The LAN ports are suitable for 100 Mbps and full duplex operation and support auto crossover and auto-negotiation. No special PROFINET functions are supported. When connecting additional Ethernet participants (PLC/panel) to the REX 200/250, it must be ensured that the IP addresses of the devices lie within the address range of the LAN interface of the REX 200/250.

9.1 Device settings: Services – Firewall – SNAT

With a REX 200/250, the SNAT function is activated by default. With this setting, participants for which no gateway*/router has been entered are accessed via the VPN tunnel. For the CPUs and panels of some manufacturers, it can be the case that you need to explicitly enter the gateway* and deactivate the SNAT function in order that a remote connection with the end device is possible.

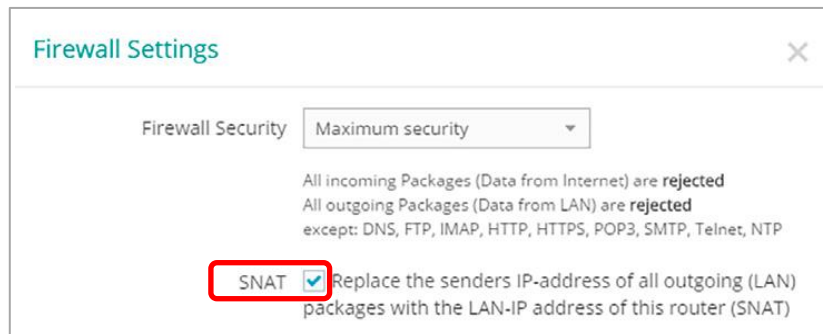

* Gateway: This refers to the configured LAN IP address of the REX 200/250.

To access a PLC or panel via the VPN tunnel, the OpenVPN adapter must be selected in the corresponding engineering tool as the interface. The virtual network connection responsible for this is the TAP Windows Adapter V9.

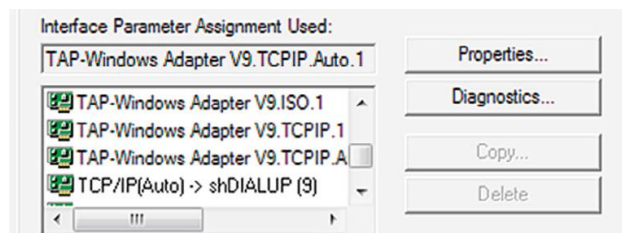

The section shown here shows the setting to be selected in the PG / PC interface module from the SIMATIC STEP 7/TIA software.

9.2 Search over IP

With the SEARCHoverIP function activated, unparameterized network components (PLCs with IP address: 0.0.0.0) can be found and configured remotely. However, this search function is not supported by all control manufacturers!



When SEARCHoverIP is activated, the "remote maintenance network" (remote client) is connected one-to-one with the LAN network on the device (router) via Layer2. These broadcasts and multicasts on the remote maintenance side generate additional data traffic through the VPN tunnel. Under certain circumstances this can lead to IP address conflicts and network disruptions on the router LAN side. It is therefore recommended to deactivate this function in normal remote maintenance mode!

In the delivery state, SEARCHoverIP is not activated.

10 Setting up the MPI/PROFIBUS interface (REX 250 only)

The following steps are necessary to maintain an S7 MPI/PROFIBUS PLC remotely with the REX 250:

10.1 Installing driver

[The current version can be downloaded at any time free of charge from www.helmholz.de](http://www.helmholz.de). Install the NETLink®-S7-NET driver on the remote maintenance PC where the engineering tool is already installed.

10.2 Creating a station

Following successful installation, the access paths of the “NETLink® PRO Family” are available in the PG/PC interface.



For the TIA Portal as well, the general assignments must first be carried out in the PG/PC interface (accessible via the Windows Control Panel).

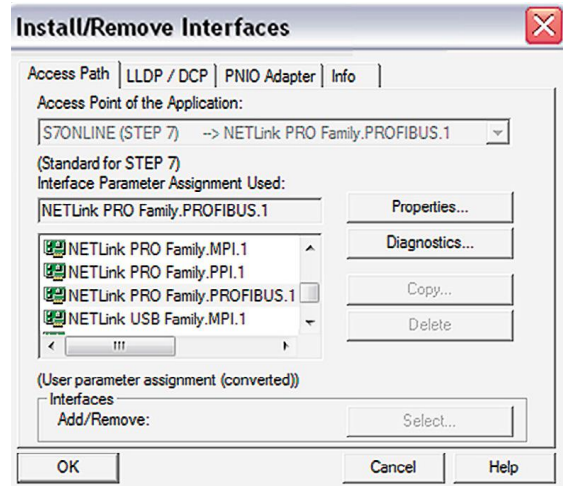

Select a configuration (MPI, PPI or PROFIBUS) and open the “Properties...” page.

10.3 Assigning an IP-Adresse and name

Click the “New” button under the “Local Connection” tab to add the REX 250. Enter the LAN IP address and the name of the router into the corresponding input fields.

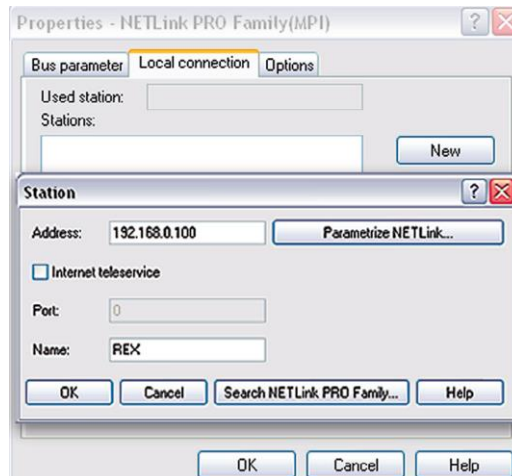

The internal communications adapter can be accessed with these settings both locally via LAN and via VPN. Then confirm with “OK”.



Please note that the port required by the REX 250 unit to communicate using the driver will be enabled by default. The “Internet teleservice” function may not be activated!

Following acceptance of the settings, it is possible to access devices on the MPI/PROFIBUS interface of the REX 250. Selection takes place via *“Set PG/PC interface”* in the programming software.

11 Setting up the VCOM LAN for serial communication (REX 250 only)

To be able to use a remote connection to access serial participants, start shDIALUP and activate the corresponding settings for the virtual COM port on your PC. To do this, click the corresponding tool button before logging in.

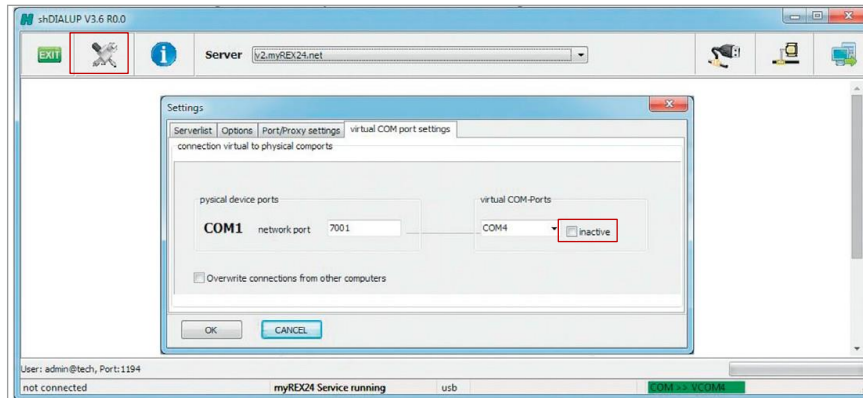

Deactivate the “Inactive” check box on the “Virtual COM Port Settings” tab. The system will automatically suggest a network port and the COM port to be used, neither of which need to be changed. Close the window by clicking “OK”. You can then use your access data to log in to the portal server and establish a connection to an REX 250 which has already been configured.

You can receive further information by activating the VCOM LAN status button.

In this example, the COM4 connection is now also available in the system in addition to the standard remote maintenance connection.

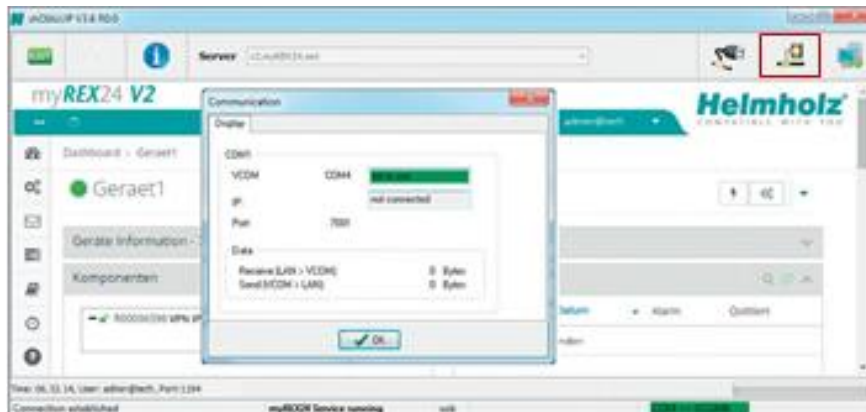

The possibility for serial communication is still indicated in the task bar by a green symbol (an active connection with a yellow symbol).

12 Description of LEDs and buttons

12.1 Function and status LEDs in normal operation

LED	LED-color	LED-status	Description
Pwr	Green	LED on	The power supply is connected to the terminal and switched on.
		LED off	The power supply to the router is interrupted/The router is not connected to the power supply
Rdy	Orange	LED on	Waiting for boot loader or signature successfully checked
		LED on	Checking signature, loading kernel
	Green	LED off	Waiting for kernel
		LED on	Boot process complete; the device can be used.
Con	Orange	LED off	No VPN connection started
		LED on	Internet connection is established, and VPN connection is started
		LED flashing	Flash frequency of 1.5 Hz: VPN connection is established
	Green	LED off	No Internet connection
		LED on	Internet connection is established
		LED flashing	Flash frequency of 3 Hz: Internet connection is being established
Stat	Red	LED off	No error
		LED flashing	Error in memory
		LED on	Error found
	Green	LED off	–
		LED on	In conjunction with the myREX24 V2 portal
Fc1			See Chapters 13 and 15
Fc2			See Chapters 13 and 15
Fc3			See Chapters 13 and 15
Fc4			See Chapter 13

12.2 RJ45 network LEDs

LED	LED-color	LED-status	Description
WAN & LAN	Orange	LED on	Network connection present
	Green	LED flashing	Network data traffic active

12.3 Buttons

FCN	The FUNCTION button is used, among other things, to establish an Internet or VPN connection (press and hold the button until the Con LED begins flashing). Other functions are described in chapters 13 and 15.
RST	Reset button for restarting the router



NOTE

If necessary, use the provided tool to activate the buttons (SIM card ejector).

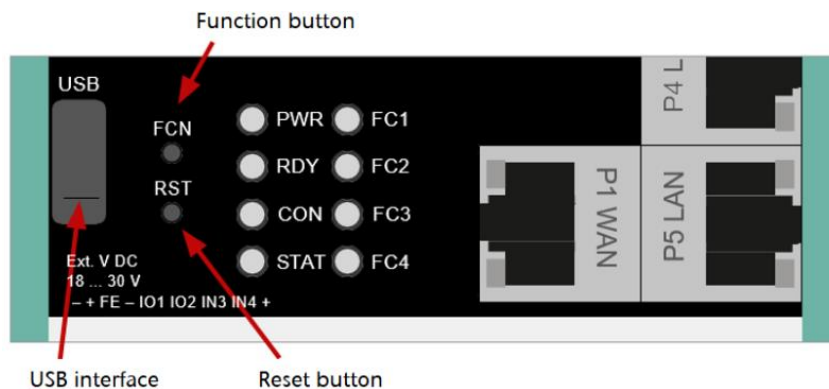

12.4 myREX24 V2 portal LEDs

●	The device is not connected with the portal.
●	The device has logged in at the portal and is thus online.
●	Depending on the device type, the router is connected to: <ul style="list-style-type: none"> - a machine (PLC) connected on the REX - the website of a connected machine - the integrated web server of the device (router)
!	The device configuration is not up to date. This means: the configuration of a newly created device has not yet been transferred to the device or the changed configuration of an existing device has not yet been transferred to the device/no synchronization has been carried out. This symbol can be displayed in connection with any of the symbols named above.

Example of the visual representation of the information points on the status of the interfaces in the "simple view".

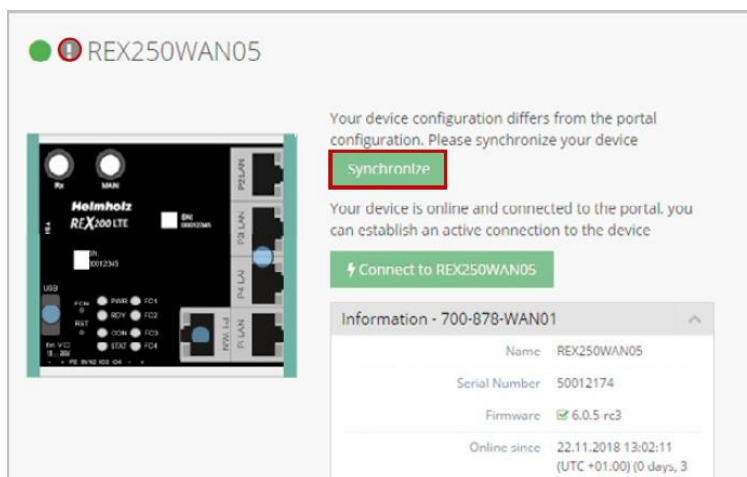

13 Resetting to factory settings

To reset the REX 200/250 to factory settings, the following steps are necessary:

- Start REX -> Apply power or press RST button (Reset)
- Wait until the RDY LED flashes green (about 30 seconds)
- Press and hold the FCN button until the FC4 LED lights orange (about 10 seconds)
- Press FCN again -> FC3 LED turns orange
- Press FCN again -> FC2 LED turns orange
- Press the FCN one last time, whereupon all FC LEDs go out
- FC3 LED flashes orange -> factory settings are being loaded

When the PWR and RDY LEDs turn green again (after about 70 seconds), the REX 200/250 is ready for use again and can be configured.



ATTENTION

Already changed login and IP address data of the LAN interface are reset (default: 192.168.0.100/24). No USB stick/storage medium may be connected to the REX 200/250.

14 Alternative configuration without myREX24 V2 portal

If you want to use the REX 200/250 without our mediation server “myREX24 V2”, you can also use another OpenVPN software or e.g., set up the IPsec encryption embedded in your hardware. If you have selected the selection for the classic router in the “First Start” screen, you can reach the corresponding step by step configurator of the web interface via the menu item “Wizards” in the upper right corner.

For the aforementioned parameterization options are appropriate Documents with application examples under www.helmholz.com free of charge available for download.

15 Load configuration from USB stick

- The REX 200/250 must be ready for use. Apply supply voltage -> After approx. 70 seconds, the PWR and RDY LEDs light up green
- Insert the USB stick with the configuration file into the USB port of the REX 200/250
- As soon as the configuration file is detected, the FC1 and FC2 LEDs flash orange (after approx. 3 seconds)
- Press the FCN button and hold it until the FC3 LED flashes orange (about 2 seconds)
- Release the FCN button
- The configuration is transferred from the USB stick to the router
- As soon as the FC3 LED goes out, the transfer is complete
- Depending on the configuration, the router tries to establish a portal connection, in this case the CON LED flashes.



ATTENTION

The configuration file to be transferred must be stored in the top directory (root) of a FAT/FAT32 formatted USB stick. The configuration file may not be renamed. An interruption of the supply voltage during the data transfer from the USB stick can put the router in an undefined state.



NOTE

Once the configuration file has been successfully transferred, the file on the USB stick will be renamed “XmyREX24.mbne” by the REX 200/250, making it impossible to accidentally reuse it a second time.

The firmware and the dial-up software "shDIALUP" of the REX 200/250 can be easily updated via the website. Please download the desired files from www.helmholz.com or scan the QR code.

[REX 200/250 Firmware and „shDIALUP“ dial-up client](#)



16 Load firmware file from the USB stick

- The REX 200/250 must be ready for operation. Apply supply voltage -> After approx. 70 seconds the PWR and RDY LEDs light up
- Insert the USB stick with the firmware file into the USB port of the REX 200/250
- As soon as the firmware file is detected, the FC1 and FC3 LEDs flash orange (after approx. 5 seconds)
- Press the FCN key and hold it until the FC2 LED flashes orange (about 2 seconds)
- Release the FCN button
- The firmware is transferred from the USB stick to the router (Duration approx. 15 seconds)
- As soon as the FC2 LED goes out, the transfer is complete
- A reboot of the REX 200/250 is performed automatically, and the process is complete when the PWR and RDY LEDs are lit solid.



ATTENTION

An interruption of the supply voltage during the data transfer Transferring from the USB stick can put the router in an undefined state! The firmware to be transferred must be stored in the top directory (root) of a FAT / FAT32 formatted USB stick. The firmware file "image.swux" must not be re-named.



NOTE

If both the firmware and a myREX24 portal configuration are found on the USB stick, the firmware is always first recognized by the REX 200/250 (Fc1 + Fc3 flashes). If you do not press the FCN button within 10 seconds, the REX 200/250 changes to the configuration file (Fc1 + Fc2 flash). If you here too do not react within 10 seconds, the router once again reverts to the normal mode.

17 Technical data

17.1 REX 200/250 WAN

Order no.	700-877-WAN02	700-878-WAN02
Article designation	REX 200 WAN	REX 250 WAN
Dimensions (DxWxH)	32,5 x 88,5 x 76,5 mm	35,5 x 100 x 76,5 mm
Weight	ca. 220 g	ca. 250 g
Number of digital inputs Type	4 DIN EN 61131-2 type 3	
Number of inputs/outputs Type	2 max. 0,5A per output	
Real-time clock	Should a power failure occur, the date and time are retained for up to 7 days (depending on the ambient temperature).	
WAN-interface	1 x	
Type	10-Base-T/100-Base-T	
Anschluss	RJ45 socket	
Transmission speed	10/100 Mbit/s	
LAN-interface	4 x	
Typ	10-Base-T/100-Base-T	
Connection	RJ45 socket	
Transmission speed	10/100 Mbit/s	
USB-interface	1 x	
Protokoll	USB 2.0 Host	
Connection	Type-A-socket	
Status indicator	8 LEDs, functional status, 10 LEDs, Ethernet-status	
Voltage supply	DC 24 V, 18 ... 30 V DC	
Current draw	max. 80 mA with DC 24 V	max. 100 mA with DC 24 V
Power dissipation	max. 2 W	max. 4 W
Environment requirements		
Ambient temperature	-40 °C ... +75 °C	
Transport and storage temperature	-40 °C ... +85 °C	
Relative humidity	95 % r. H. without condensation	
Pollution degree	2	
Protection rating	IP20	
VPN		
Protocol	IPsec/PPTP/OpenVPN, 64 tunnels	
Encryption method	AES (256-, 192, 128-Bit), Blowfish (128-Bit), 3DES (168-Bit), DES (56-Bit)	
Encryption algorithms	SHA-2 (SHA-256, SHA-512), SHA-1, MD5	
Authentication	Pre-Shared-Key, X.509	
Network/Security		
Firewall	1:1 NAT, IP-filter, port-forwarding, stateful inspection	
IP-router	NAT-IP, TCP/IP routing, IP forwarding	
Services	DHCP server, DHCP client, DNS server, NTP client, PPP server, DynDNS	
Time comparison	NTP server	

17.2 Additional interfaces REX 250

Serial interface	1 x
Type	RS-232/422/485 (switchable via software)
Protocol	transparent access via virtual COM port
Connection	plug SUB-D, 9-pin
Transmission speed	300 Baud ... 115 kBaud
MPI/PROFIBUS interface	1 x
Type	RS-232/485 (switchable via software)
Connection	socket, SUB-D, 9-pin
Transmission speed	Up to 12Mbps

Serial / Profibus

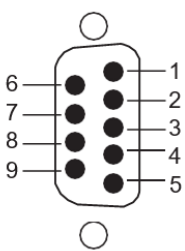

Pin	RS 232	RS 485	MPI/PROFIBUS
1	DCD Data Carrier Detect	Not used	Not used
2	RxD Receive Data	RxD- Receive Data	Not used
3	TxD Transmit	TxD+ Transmit Data	Data line B
4	DTR Data Terminal Ready	+ 5 Volt (only with 4-wire operation)	CNTR-P
5	Signal Ground	Signal Ground	GND 5 V (200 mA)
6	DSR Data Set Ready	Not used	5 V Output
7	RTS Request To Send	TxD- Transmit Data	Not used
8	CTS Clear To Send	RxD+ Receive Data	Data line A
9	RI Not used	Not used	Not used

17.3 REX 200/250 LTE

Order no.	700-877-LTE02	700-878-LTE02
Article designation	REX 200 LTE	REX 250 LTE
Current draw	max. 140 mA with DC 24 V	max. 160 mA with DC 24 V
Power dissipation	max. 3,5 W	max. 4 W
LTE-Modem - EMEA	4G - (Europe/Asia)	
GSM modem type	Multiband GSM/GPRS/WCDMA/LTE Data Interface	
Antenna terminal	2 x SMA-plug (external thread)	
SIM-Card type	Mini SIM (2FF) 1,8 V/3 V	
GSM-frequency bands	B3, B8	
UMTS-frequency bands	B1 [from HW x-x-3B], B2 [up to HW x-x-3A], B3 [from HW x-x-3B], B8	
LTE-frequency bands (MHz)	B1, B3, B7, B8, B20 [only HW x-x-3A], B28A [from HW x-x-3B]	
Transmit power	Class 1 (1W) DCS 1800, Class 4 (2W) GSM 900, Class 3 (0,25W, 23dBm) 3G, Class 3 (0,2W, 23 dBm) LTE	
Data transmission rate	LTE Cat4. - Uplink max. 50 Mbit/s Downlink max. 150 Mbit/s	

17.4 REX 200/250 WiFi

Order no.	700-877-WIF02	700-878-WIF02
Article designation	REX 200 WiFi	REX 250 WiFi
Current draw	max. 90 mA with DC 24 V	
Power dissipation	max. 3 W	
Ambient temperature	0°C ... +60°C	
Transport and storage temperature	-20°C ... +80°C	
WLAN-interface	RP-SMA socket	
Type	IEEE802.11b/g & 802.11n (1T1R mode)	
Frequency range	EU (2.412 GHz - 2.472 GHz, 1-13 Channel)	
Maximum output power	19 dBm EIRP, RF power including maximum antenna gain (3 dBi)	
Transmission speed	802.11b: 1, 2, 5.5, 11 Mbps 802.11g: 6, 9, 12, 18, 24, 36, 48, 54 Mbps 802.11n: MCS0-MCS7 (max 72.2Mbps)	
Wireless-Security-methods	AES/CCMP, WEP/TKIP	
FCC	Contains FCC ID: XPYLILYW1 IC: 8595A-LILYW1	



The contents of this Quick Start Guide have been checked by us so as to ensure that they match the hardware and software described. However, we assume no liability for any existing differences, as these cannot be fully ruled out. The information in this Quick Start Guide is, however, updated on a regular basis. When using your purchased products, please make sure to use the latest version of this Quick Start Guide, which can be viewed and downloaded on the Internet from www.helmholz.de.

Our products contain open-source software, among others. This software is subject to the respectively relevant license conditions. We can send you the corresponding license conditions, including a copy of the complete license text together with the product. They are also provided in our download area of the respective products under www.helmholz.de. We also offer to send you or any third party the complete corresponding source text of the respective open-source software for an at-cost fee of 10.00 Euro as a DVD upon request. This offer is valid for a period of three years, starting from the date of product delivery.

Our customers are important to us, we are happy to receive suggestions and ideas for improvement. If you have any questions regarding the use of the product, please contact Helmholtz Support by phone or send an e-mail to support@helmholz.de.

All trademarks shown or mentioned in this document are the property of their respective owners or manufacturers. The representation and naming serve exclusively to explain the use and setting options of the products documented here.