

PCD1.M2220-C15

E-Line CPU with Ethernet, 512 kB



The Saia PCD1 E-Line CPU series was specifically developed for installation in electrical sub-distributors. The compact design enables automation in confined spaces. The E-Line CPU is designed and produced to industrial quality in accordance with IEC 61131-2.

The extensive programmability and integration of web+IT technologies enables effective automation over the entire service life of plants and properties. The Saia PCD E-Line CPU is the ideal interface for other plants owing to the support of numerous protocols such as BACnet, Lon, Modbus, etc. It is also ideal to achieve (energy-) efficient and individual room automation. It also provides a good basis to achieve the energy efficiency classes in accordance with EN 15232:2012.

Device design

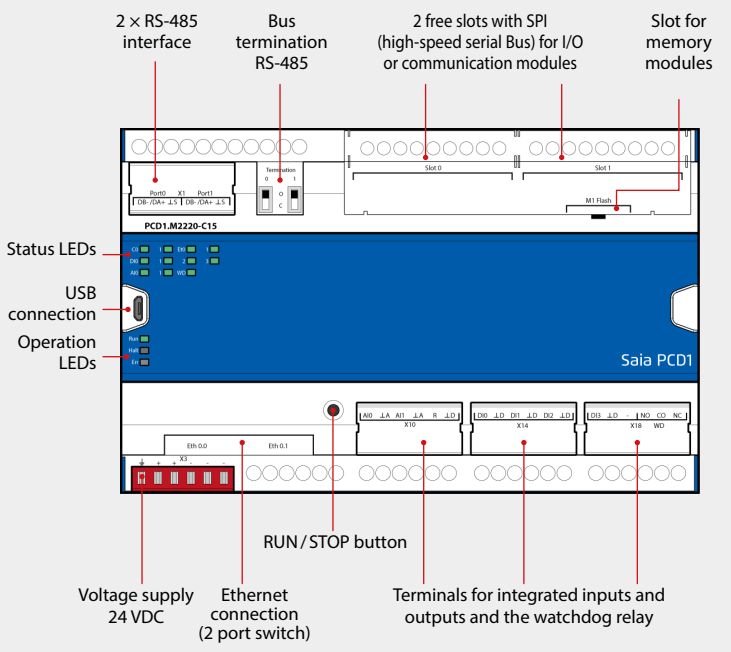

Features

- ▶ 4 digital inputs
- ▶ 2 analogue inputs, individually configurable via software
- ▶ 1 Watchdog relay/changeover contact
- ▶ Electrical isolation between supply, bus and I/Os
- ▶ Pluggable terminal blocks protected by flaps
- ▶ Status LEDs on the front
- ▶ 2 I/O module sockets
- ▶ Ethernet switch, 2x RS-485 and USB interface
- ▶ Large onboard memory for data (up to 128 MByte file system)
- ▶ Automation server for integration in web+IT systems
- ▶ Freely programmable with Saia PG5®
- ▶ FRAM technology

AUTOMATION SERVER
 INTEGRATED
 IN THE BASE UNIT

Dimensions and installation

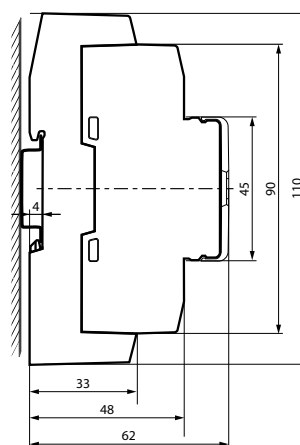
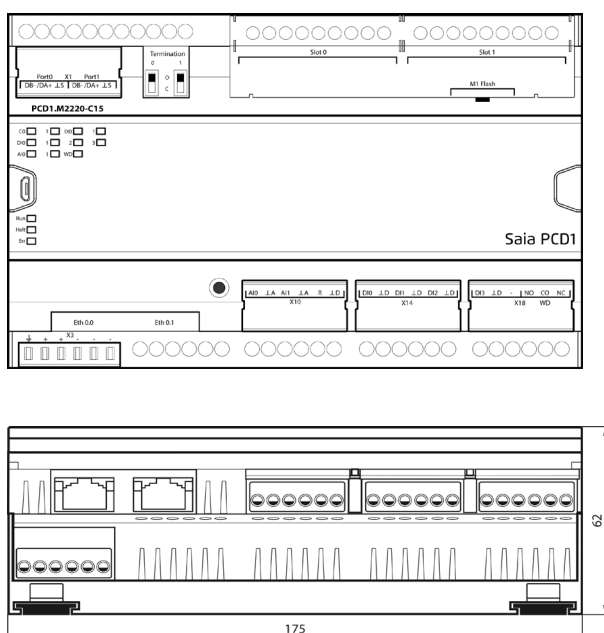

on DIN rails 35 mm
(in accordance with DIN EN 60715 TH35)

Connection concept

The device is supplied by a 24 VDC or AC voltage supply.

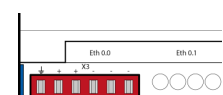

Housing width 10 HP (175 mm)
Compatible with electrical control cabinets
(in accordance with DIN 43880, size 2 x 55 mm)

General technical data

Power supply

Supply voltage	Nominal 24 VAC (50 Hz) or DC, 24 VDC, -20/+25% incl. 5% ripple, 24 VAC, -15%/+15% (in accordance with EN/IEC 61131-2)
Electrically isolated	500 VDC between power supply and RS-485 as well as I/Os
Power consumption	6.5 W

Interfaces

Communications interface	2x RS-485 with galvanic isolation, baud rate: 1200, 2400, 5600, 9600, 19200, 38400, 57600, 115200 bps
Terminating resistors	Each connectable using a switch
SBus address	Address range: 0...253 by Saia PG5® Device Configurator
Service interface	Micro USB, NFC (near field communication)
Ethernet connection	(2-port switch) 10/100 Mbit/s, full-duplex, auto-sensing, auto-crossing
Onboard field level protocols	Serial S-Bus, Ether S-Bus, Modbus RTU or TCP
Optional interface in I/O slots	PCD2.F2xxx (with slot for PCD7.F1xxS modules)
Slot M1 for protocol extension	LON over IP (PCD7.R58x module), BACnet® (PCD7.R56x module)

Memory and file system

Program memory, DB/text (Flash)	512 kByte
User memory, DB/text (FRAM)	128 kByte
Onboard user flash file system	128 MByte

General data

Ambient temperature	Operation: 0 ... +55 °C Storage: -40 ... +70 °C
---------------------	--

Input/output configuration

Digital inputs

Number	4
Input voltage	24 VAC / VDC source operation (positive switching) or sink operation
Switching level	Low: 0...5 V, High: 15...24 V
Input current	Typically 2 mA (AC/DC)
Input delay	20 ms (AC), 2 / 8 ms (DC)

Relay outputs

1 Watchdog relay or as changeover contact	48 VAC or VDC, 1 A (mount a freewheeling diode over the load when switching DC tension)
---	---

Analogue inputs

Number	2
Potential isolation	No
Signal range and measured values (can be set via FBoxes)	Voltage measurement -10 V ... +10 V Resistance 0 Ω ... 2500 Ω Pt1000 -50 °C ... +400 °C Ni1000 -50 °C ... +210 °C Ni1000 L&S -30 °C ... +140 °C
	+/- 20V (independent of input configuration) voltages > 15 V / < -15 V, can result in incorrect values at other inputs
Input delay	Channel update 10 ms (all channels are updated during this time) Hardware input filter time constant Voltage measurement $\tau = 2.5$ ms Resistance $\tau \approx 8$ ms Software input filter Connectable using Saia PG5® Device Configurator (forms the average value of the last 16 values)

Mode	Resolution [bit]	Resolution [measured value]	Accuracy (at T _{Ambient} = 25 °C)	Display
Voltage -10 V ... +10 V	12 + sign	2.44 mV (linear) $R_{IN} = 220$ kΩ	0.3% of the measured value +/- 10 mV	0...1000 (standard) or user scaling
Resistance 0...2500 Ω	12	0.50 ... 0.80 Ω Measured current: 1.0 ... 1.3 mA	0.3% of the measured value +/- 3 Ω	0...25000
Pt 1000	12	-50 .. +400 °C: 0.15 .. 0.25 °C Measured current: 1.0 ... 1.3 mA	0.3% of the measured value +/- 0.5 °C	-500...4000
Ni 1000	12	-50 .. +210 °C: 0.09 .. 0.11 °C Measured current: 1.0 ... 1.3 mA	0.3% of the measured value +/- 0.5 °C	-500...2100
Ni 1000 L&S	12	-30 .. +140 °C: 0.12 ... 0.15 °C Measured current: 1.0 ... 1.3 mA	0.3% of the measured value +/- 0.5 °C	-300...1400

Terminal technology

Rigid or flexible wires with a diameter of up to 1.5 mm² can be used. A max. of 1 mm² is permitted with wire ferrules.

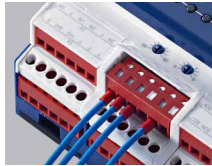

Connection concept

The device is supplied by a 24 VDC or AC voltage supply.

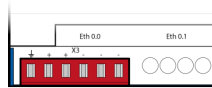

Bus wiring

DB- and /DA+ terminals must be used for exchanging data between the modules. The bus is through-wired to a terminal to ensure the exchange between modules to avoid an interruption in the bus connection.

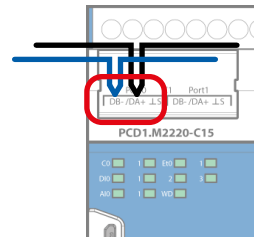

Flexible RS-485 cables with a cross section of no more than 0.75 mm² are permissible for bus wiring. A cable cross section of 1.5 mm² per terminal applies overall.

Assignment overview

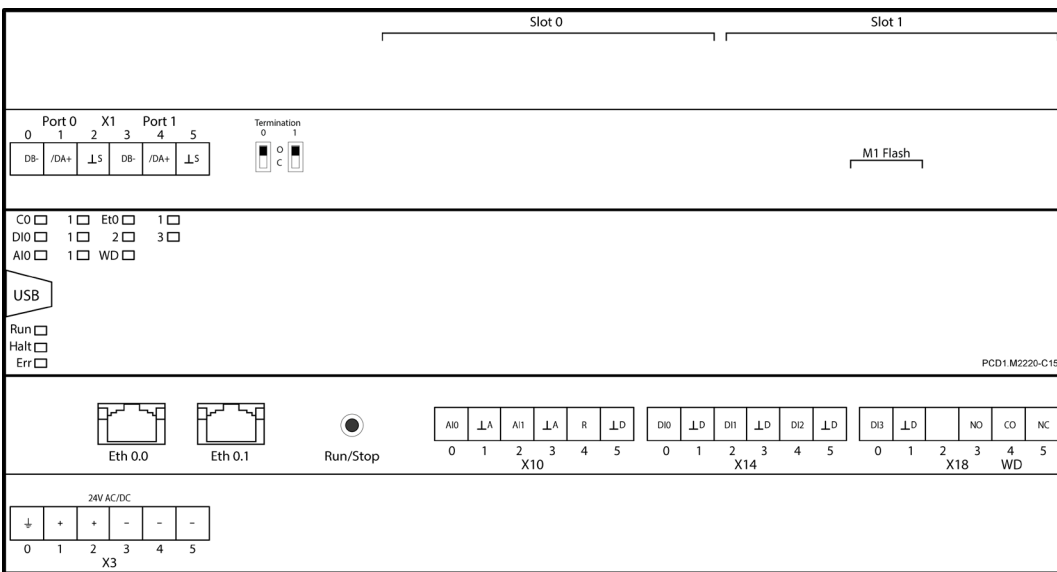

PCD1.M2220-C15

Connection diagrams

Digital input

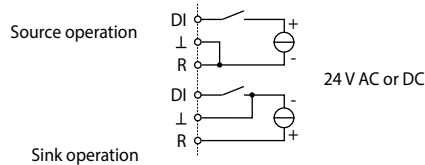

Analogue input

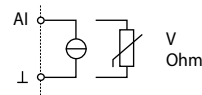

Relay (1A) as Watchdog or changeover

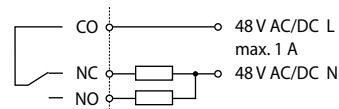

GND	┴	ground
DGND	┴D	digital galvanic isolated ground
AGND	┴A	analogue galvanic isolated ground
SGND	┴S	signal ground
a, b, .. alphanumeric index by different grounds		

Plug-in I/O modules for slots I/O #0 and I/O #1

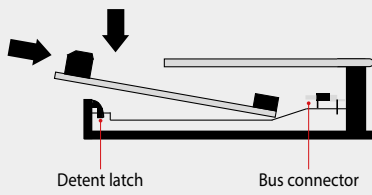

I/O #1

I/O #0

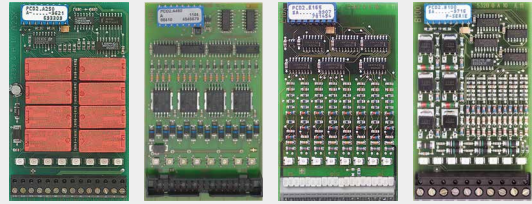

A selection of over 50 different I/O modules with various functions is available.

Instead of I/O modules, PCD2.F2xxx interface cards for RS-232, RS-422, RS-485, BACnet MS/TP, Lon FFT, DALI, M-Bus or Belimo MP Bus can be used.



ATTENTION

These devices must only be installed by a professional electrician, otherwise there is the risk of fire or the risk of an electric shock.



WARNING

Product is not intended to be used in safety critical applications, using it in safety critical applications is unsafe.



WARNING - Safety

The unit is not suitable for the explosion-proof areas and the areas of use excluded in EN 61010 Part 1.



WARNING - Safety

Check compliance with nominal voltage before commissioning the device (see type label). Check that connection cables are free from damage and that, when wiring up the device, they are not connected to voltage.



NOTE

In order to avoid moisture in the device due to condensate build-up, acclimatise the device at room temperature for about half an hour before connecting.



CLEANING

The device can be cleaned in dead state with a dry cloth or cloth soaked in soap solution. Do not use caustic or solvent-containing substances for cleaning.



MAINTENANCE

These devices are maintenance-free. If damaged, no repairs should be undertaken by the user.



GUARANTEE

Opening the module invalidates the guarantee.



WEEE Directive 2012/19/EC Waste Electrical and Electronic Equipment directive

The product should not be disposed of with other household waste. Check for the nearest authorized collection centers or authorized recyclers. The correct disposal of end-of-life equipment will help prevent potential negative consequences for the environment and human health.



PCD1.M2220-C15



Terminal set
32304321-003-5



Details about this CPU can be found in the manual 27-640 ENG "PCD1.M2220-C15 E-Line CPU".



EAC Mark of Conformity for Machinery Exports to Russia, Kazakhstan or Belarus.



I/O modules and I/O terminal blocks may only be plugged in and removed when the Saia PCD® and the external +24 V are disconnected from the power supply.

Order details

Type	Short description	Description	Weight
PCD1.M2220-C15	Saia PCD® E-Line CPU base unit	E-Line processor unit with Ethernet TCP/IP for electrical switch cabinet, web and FTP server, file system, 512 KByte user program, 128 KByte RAM DB/Text, 128 MByte Flash memory, 2 I/O module sockets, 1 M socket, 4 digital inputs, 2 analogue inputs, 1 watchdog 4 interfaces: RS-485 (S-Bus), auxiliary RS-485, USB & NFC (service) Supply 24 VAC/VDC	550 g
32304321-003-5	Terminal set	6-pin terminal. Set of 6 terminal blocks	40 g

Saia-Burgess Controls AG

Bahnhofstrasse 18 | 3280 Murten, Switzerland
T +41 26 580 30 00 | F +41 26 580 34 99
www.saia-pcd.com

support@saia-pcd.com | www.sbc-support.com